



Всеукраїнський науково-технічний журнал

All-Ukrainian Scientific & Technical Journal

ISSN 2520-6168 (Print)

DOI:10.37128/2520-6168-2023-3

Machinery  
Energetics  
Transport  
of Agribusiness

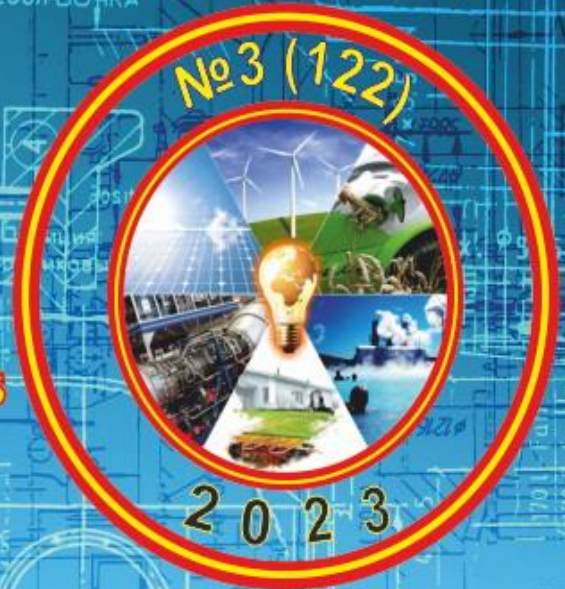

ТЕХНІКА  
ЕНЕРГЕТИКА  
ТРАНСПОРТ АПК





*Всеукраїнський науково-технічний журнал*

**ТЕХНІКА,  
ЕНЕРГЕТИКА,  
ТРАНСПОРТ АПК**

*№ 3 (122) / 2023*

**м. Вінниця - 2023**

**ТЕХНІКА,  
ЕНЕРГЕТИКА,  
ТРАНСПОРТ АПК**

Журнал науково-виробничого та навчального спрямування  
Видавець: Вінницький національний аграрний університет

Заснований у 1997 році під назвою «Вісник Вінницького державного сільськогосподарського інституту».  
Правонаступник видання: Збірник наукових праць Вінницького національного аграрного університету. Серія: Технічні науки.  
Свідоцтво про державну реєстрацію засобів масової інформації  
КВ № 16644–5116 ПР від 30.04.2010 р.

*Всеукраїнський науково – технічний журнал «Техніка, енергетика, транспорт АПК» /  
Редколегія: Токарчук О.А. (головний редактор) та інші. Вінниця, 2023. № 3 (122). С. 140.*

*Друкується за рішенням Вченої ради Вінницького національного аграрного університету  
(протокол № 7 від 02.12.2023 р.)*

*Свідоцтво про державну реєстрацію засобів масової інформації №21906-11806 Р від 12.03.2016р.*

*Журнал «Техніка, енергетика, транспорт АПК» включено до переліку наукових фахових видань  
України з технічних наук (Категорія «Б», Наказ Міністерства освіти і науки України  
від 02.07.2020 року №886);*

*- присвоєно ідентифікатор цифрового об'єкта (Digital Object Identifier – DOI);*

*- індексується в CrossRef, Google Scholar;*

*- індексується в міжнародній наукометричній базі [Index Copernicus Value](#) з 2018 року.*

**Головний редактор**

*Токарчук О.А.* – к.т.н., доцент, Вінницький національний аграрний університет

**Заступник головного редактора**

*Веселовська Н.Р.* – д.т.н., професор, Вінницький національний аграрний університет

**Відповідальний секретар**

*Полєвода Ю.А.* – к.т.н., доцент, Вінницький національний аграрний університет

**Члени редакційної колегії**

*Булгаков В.М.* – д.т.н., професор, академік НААН України, Національний університет біоресурсів і природокористування України

*Солоня О.В.* – к.т.н., доцент, Вінницький національний аграрний університет

*Граняк В.Ф.* – к.т.н., доцент, Вінницький національний аграрний університет

*Спірін А.В.* – к.т.н., доцент, Вінницький національний аграрний університет

*Іванчук Я.В.* – к.т.н., доцент, Вінницький національний технічний університет

*Твердохліб І.В.* – к.т.н., доцент, Вінницький національний аграрний університет

*Іскович – Лотоцький Р.Д.* – д.т.н., професор, Вінницький національний технічний університет

*Цуркан О.В.* – д.т.н., професор, Вінницький національний аграрний університет

*Купчук І.М.* – к.т.н., доцент, Вінницький національний аграрний університет

*Яронуд В.М.* – к.т.н., доцент, Вінницький національний аграрний університет

**Зарубіжні члени редакційної колегії**

*Йордан Максимов* – д.т.н., професор, Технічний університет Габрово (Болгарія)

*Аудріус Жунда* – к.т.н., доцент, Університет Вітовта Великого (Литва)

Відповідальний секретар редакції **Полєвода Ю.А.** – к.т.н., доцент, Вінницький національний аграрний університет  
Адреса редакції: 21008, Вінниця, вул. Сонячна 3, Вінницький національний аграрний університет,  
тел. (0432) 46–00–03

Сайт журналу: <http://tetapk.vsau.org/>

Електронна адреса: [pophv@ukr.net](mailto:pophv@ukr.net)



## ЗМІСТ

## I. ПРИКЛАДНА МЕХАНІКА. МАТЕРІАЛОЗНАВСТВО. ГАЛУЗЕВЕ МАШИНОБУДУВАННЯ

*Алієв Е.Б., Кошулько В.С., Кочережко Н.В.***ОБҐРУНТУВАННЯ КОНСТРУКТИВНО-ТЕХНОЛОГІЧНИХ ПАРАМЕТРІВ РОТОРНОГО ЗМІШУВАЧА КОМБІКОРМІВ ПЕРІОДИЧНОЇ ДІЇ.....** 5*Igor Zozulyak***SIMULATION OF THE PROCESS OF VIBRATING SUNFLOWER DRYING.....** 14*Михалеви́ч В.М., Штуць А.А., Колі́сник М.А.***ДОСЛІДЖЕННЯ ПРОЦЕСІВ ШТАМПУВАННЯ ОБКОЧУВАННЯМ ЗА РАХУНОК АНАЛІЗУ МОДЕЛЮВАННЯ ДЕФОРМОВНОСТІ МАТЕРІАЛУ ЗАГОТОВОК.....** 22*Yuri Paladiychuk, Inna Telyatnik, Marina Kubai***RESEARCH OF THE VIBRATORY FORMATION OF THE COMPASSION OF POWDER MATERIALS BY HYDRO-IMPULSE LOADING.....** 35*Яропу́д В.М., Говору́ха В.Б., Дацю́к Д.А.***ЕКСПЕРИМЕНТАЛЬНІ ДОСЛІДЖЕННЯ ДОЗАТОРА ВИСІВНОГО АПАРАТА СЕЛЕКЦІЙНОЇ СІВАЛКИ ДРІБНОНАСІННЄВИХ КУЛЬТУР.....** 43

## II. АГРОІНЖЕНЕРІЯ

*Борис М.М., Мартинюк А.В., Грицун А.В., Швець Л.В.***ОСОБЛИВОСТІ ВЗАЄМОДІЇ РОТОРНИХ ОЧИСНИКІВ З ГОЛОВКАМИ КОРЕНЕПЛОДІВ ЦУКРОВИХ БУРЯКІВ.....** 53*Заєць М.Л.***МОДЕЛЮВАННЯ ПРОЦЕСУ ЕКСТРАКЦІЇ КОРЕНЕПЛОДІВ ЦУКРОВИХ БУРЯКІВ З ВРАХУВАННЯМ ДИНАМІКИ НАЛИПАННЯ ҐРУНТУ НА ЇХНІЙ ПОВЕРХНІ.....** 63*Єленич А.П.***КОНСТРУКТИВНІ ОСОБЛИВОСТІ ТРАКТОРІВ КОМПАНІЇ MASSEY FERGUSON.....** 71*Iryna Hunko, Oleksandr Kholodiuk, Roman Lipnitskiy***WAYS TO STABILIZE THE CONDITION OF THE TRANSPORTATION OF AGRICULTURAL PRODUCTS IN THE CONDITIONS OF LARGE-SCALE RUSSIAN AGGRESSION.....** 82*Olena Trukhanska, Oleksii Ostapenko***IMPROVING THE ORGANIZATION OF CENTRALIZED RESTORATION OF AGRICULTURAL EQUIPMENT PARTS.....** 90*Павленко С.І.***ТЕХНІКО-ЕКОНОМІЧНА ОЦІНКА ВИРОБНИЦТВА КОМПОСТІВ З ПІДСТИЛКОВОГО ПОСЛІДУ В УМОВАХ ГОСПОДАРСТВА.....** 96*Shvets Ludmila, Valerii Ostapenko***DEVELOPMENT OF MACHINE UNIT FOR RESOURCE-SAVING TECHNOLOGIES OF SOIL PROCESSING.....** 109

## III. ЕЛЕКТРОЕНЕРГЕТИКА, ЕЛЕКТРОТЕХНІКА ТА ЕЛЕКТРОМЕХАНІКА

*Бойко С.М., Жуков О.А., Саблін О.І., Риков Г.Ю.***ПРИНЦИПИ ЗАСТОСУВАННЯ АЛЬТЕРНАТИВНИХ ДЖЕРЕЛ ЕНЕРГІЇ В РЕГІОНАХ З ОБМЕЖЕНИМИ РЕСУРСАМИ ПИТНОЇ ВОДИ.....** 116*Граняк В.Ф., Кожушко О.В.***ЕКСПРЕС МЕТОД ВИЗНАЧЕННЯ МОМЕНТНИХ ХАРАКТЕРИСТИК АСИНХРОННИХ ЕЛЕКТРОДВИГУНІВ.....** 124*Svetlana Kravets***TECHNOLOGICAL PROGRESS IN SOLAR PANELS: ACHIEVEMENTS AND INNOVATIONS.....** 131

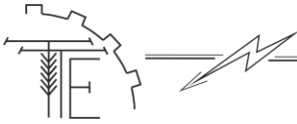

## CONTENTS

## I. APPLIED MECHANICS. MATERIALS SCIENCE. INDUSTRY MACHINERY BUILDING

<i>Elchyn Aliiev, Vitalii Koshulko, Nazar Kocherezhko</i> <b>JUSTIFICATION OF THE DESIGN AND TECHNOLOGICAL PARAMETERS OF THE ROTOR MIXER OF PERIODIC ACTION COMBINED FEED.....</b>	<b>5</b>
<i>Igor Zozulyak</i> <b>SIMULATION OF THE PROCESS OF VIBRATING SUNFLOWER DRYING.....</b>	<b>14</b>
<i>Volodymyr Mikhalevich, Andrii Shtuts, Mykola Kolisnyk</i> <b>INVESTIGATION OF STAMPING BY WRAPPING PROCESSES THROUGH MATERIAL DEFORMATION MODELING ANALYSIS.....</b>	<b>22</b>
<i>Yuri Paladiychuk, Inna Telyatnik, Marina Kubai</i> <b>RESEARCH OF THE VIBRATORY FORMATION OF THE COMPASSION OF POWDER MATERIALS BY HYDRO-IMPULSE LOADING.....</b>	<b>35</b>
<i>Vitalii Yaropud, Volodymyr Govorukha, Dmytro Datsiuk</i> <b>EXPERIMENTAL STUDIES OF THE DISPENSER OF THE SEEDING APPARATUS OF THE SELECTION SEEDER OF SMALL SEED CULTURES.....</b>	<b>43</b>

## II. AGROENGINEERING

<i>Mykola Borys, Andrii Martynyuk, Anatolii Hrytsun, Shvets Ludmila</i> <b>FEATURES OF THE INTERACTION OF ROTARY CLEANERS WITH THE HEADS OF SUGAR BEET ROOTS.....</b>	<b>53</b>
<i>Maksym Zayets</i> <b>MODELING OF WORKING BODIES FOR THE EXTRACTION OF SUGAR BEET ROOTS TAKING INTO ACCOUNT THE DYNAMICS OF SOIL STICKING ON THEIR SURFACE.....</b>	<b>63</b>
<i>Anatoliy Yelenych</i> <b>DESIGN FEATURES OF TRACTORS MASSEY FERGUSON COMPANIES.....</b>	<b>71</b>
<i>Iryna Hunko, Oleksandr Kholodiuk, Roman Lipnitskiy</i> <b>WAYS TO STABILIZE THE CONDITION OF THE TRANSPORTATION OF AGRICULTURAL PRODUCTS IN THE CONDITIONS OF LARGE-SCALE RUSSIAN AGGRESSION.....</b>	<b>82</b>
<i>Olena Trukhanska, Oleksii Ostapenko</i> <b>IMPROVING THE ORGANIZATION OF CENTRALIZED RESTORATION OF AGRICULTURAL EQUIPMENT PARTS.....</b>	<b>90</b>
<i>Sergii Pavlenko</i> <b>TECHNICAL AND ECONOMIC EVALUATION OF THE PRODUCTION OF COMPOSTS FROM LITTER MANURE IN THE CONDITIONS OF THE FARM.....</b>	<b>96</b>
<i>Shvets Ludmila, Valerii Ostapenko</i> <b>DEVELOPMENT OF MACHINE UNIT FOR RESOURCE-SAVING TECHNOLOGIES OF SOIL PROCESSING.....</b>	<b>109</b>

## III. ELECTRICAL ENERGY, ELECTRICAL ENGINEERING AND ELECTROMECHANICS

<i>Serhii Boiko, Oleksii Zhukov, Oleg Sablin, Hennadii Rykov</i> <b>PRINCIPLES OF APPLICATION OF ALTERNATIVE ENERGY SOURCES IN REGIONS WITH LIMITED DRINKING WATER RESOURCES.....</b>	<b>116</b>
<i>Valerii Hraniak, Oleksandr Kozhushko</i> <b>EXPRESS METHOD OF DETERMINING INSTANT CHARACTERISTICS OF ASYNCHRONOUS ELECTRIC MOTORS.....</b>	<b>124</b>
<i>Svetlana Kravets</i> <b>TECHNOLOGICAL PROGRESS IN SOLAR PANELS: ACHIEVEMENTS AND INNOVATIONS.....</b>	<b>131</b>

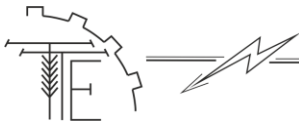

UDC 66.047

DOI: 10.37128/2520-6168-2023-3-2

**SIMULATION OF THE PROCESS OF VIBRATING SUNFLOWER DRYING**

**Igor Zozulyak**, Candidate of Technical Sciences, Senior Lecturer  
Vinnytsia National Agrarian University

**Зозуляк Ігор Анатолійович**, к.т.н., ст. викладач  
Вінницький національний аграрний університет

*This work is devoted to the research and substantiation of the technology of drying sunflower seeds and the development of technological and technical proposals for the creation of drying equipment that would ensure work on this crop, both in seed and food modes.*

*The technological value of sunflower seeds is determined by their oil content. Therefore, it is important to preserve the quantity and quality of oil. Under optimal drying conditions, the oil content in sunflower seeds increases. Therefore, the question of selecting technological equipment for the drying process arises.*

*Analysis of the mechanical and technological parameters of series-produced dryers showed that these machines are mainly intended for the processing of grain crops. The disadvantages of well-known mine grain dryers are low moisture removal during one pass of the material through the dryer, overheating of the seed and a decrease in its quality in the area of contact with the surface of the intake boxes, increased fire hazard. Drum grain dryers when drying sunflower seeds are very fire-hazardous and do not allow obtaining seeds with uniform moisture content, and the use of high-temperature modes leads to a decrease in the sowing qualities of seeds due to overheating. When drying sunflower seeds in recirculation type dryers, it is very important to evenly distribute the seeds over the entire cross-section of the chamber, as well as to prevent the accumulation of oil dust in the heating chamber and to eliminate the ingress of sparks from the furnace into the heating chamber. One of the promising methods of drying bulk materials is the method of drying in a vibrating fluidized bed, which can be achieved on vibrating dryers of various types.*

*A number of experiments were conducted to substantiate the technological and technical proposals for the process of drying sunflower seeds and to determine the operating parameters of the dryer. Based on the results, graphs were constructed. The results of the research proved the expediency and necessity of using vibrating dryers during drying of sunflower seeds. The best parameters of the infrared radiation drying process with a selected wavelength of 1,5-3,0  $\mu\text{m}$ , a sunflower seed layer height of 15 mm, and a heat flow density of IR radiation were found. 5  $\text{kW/m}^2$ , the height of the placement of the IR generator blocks relative to the layer of the irradiated product is 25 mm, while the drying time will be 11 minutes.*

**Key words:** sunflower, drying, dryer, humidity, container, electric motor, oscillations, vibration.

**Fig. 5. Ref. 8.**

---

**1. Problem formulation**

---

The main oil crop in Ukraine is sunflower. Fresh sunflower seeds cannot be stored for a long time. It contains a large number of proteins and fats, which undergo chemical changes under the influence of high air humidity, low temperature and contamination, which leads to its spoilage.

For long-term storage, sunflower seeds with no more than 2% dirt should be stored, dried to critical humidity (6...7%) and cooled to low positive temperatures. The duration of storage under such conditions is 3...6 months, if the temperature of the dried seeds before storage or during the first 15 days of storage is reduced to 0...10 °C.

Sunflower seeds with a moisture content of less than 12% awaiting drying can be temporarily placed in warehouses equipped with active ventilation, and those with a moisture content of more than 12% must be dried immediately.

The technological value of sunflower seeds is determined by their oil content. Therefore, it is important to preserve the quantity and quality of oil. In the drying process, either synthesis or decomposition of fat components can occur. The direction of these transformations depends on the humidity of the seed, on the temperature and duration of its heating. Under optimal drying conditions, the oil content in sunflower seeds increases. Associated substances contained in the seeds pass through the oil: phosphatites, carotenoids, sterols, waxy substances.

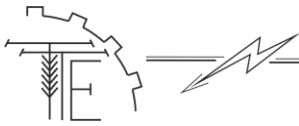

The most important process in oil seed production technology is drying, the quality of the future oil and seed material depends on the execution of this process. However, the available domestic drying agents do not meet all the requirements, because they do not take into account the features of sunflower seeds, which are significantly different from grain, in particular, low flowability, especially seeds with high moisture content, low mechanical strength of the husk, increased porosity of the seed mass and, especially important, the fire hazard of sunflower seeds [1].

Timely drying of sunflower seeds will make it possible to preserve its nutritional value for a long time. Seeds can be dried in different types of drying machines, the drying mode depends on its initial humidity and oil content.

---

## 2. Analysis of recent research and publications

---

Analysis of the mechanical and technological parameters of series-produced dryers showed that these machines are mainly intended for the processing of grain crops.

During the drying of sunflower seeds in mine dryers, it is necessary to initially clean them of weedy impurities, as they can lead to clogging of the dryer and its ignition. Most of the seeds intended for storage are dried in dryers of this type. Seeds with high moisture content can be dried twice, and often three times in such a drying apparatus. At the same time, the flow of processing is disturbed, which causes difficulties in working with the seeds that come in again. As a result of the uneven movement of the mine sections during its treatment with hot air, the seed heats up unevenly, the temperature difference can be up to 10 °C. This is due to the fact that seeds move more slowly near the walls of the mines than in the center. In addition, the insufficient throughput of the dryer can lead to overheating of some of the seeds. To prevent this from happening, a horizontal partition, usually a metal one, is placed over the partition of the superdrying hopper, which is located above the air distribution chamber [2].

The disadvantages of well-known mine grain dryers are low moisture removal during one pass of the material through the dryer, overheating of the seed and reduction of its quality in the area of contact with the surface of the water boxes, increased fire hazard, and the impossibility of processing the mass of sunflower seeds with high humidity and clogging in one pass through the mine.

Of all mine dryers for drying sunflower seeds, it is most rational to use paired dryers. They can dry seeds using different technologies, depending on their initial moisture content. If the moisture content of the seeds is less than 15%, then the sunflower seeds are dried in one step, according to the drying-cooling scheme, while both devices function in parallel. If the humidity is in the range of 15-20%, the seeds are sequentially passed through both devices according to the scheme of drying-laying-drying-cooling, while the fan of the cooling zone of the first dryer is not used. If the moisture content of the seeds is more than 20%, the cooling shaft of the first device is used as a dryer by connecting it to the furnace [1].

In the oil and fat industry, drum dryers with different drying modes depending on the moisture content of raw seeds are used for drying seeds. The temperature of the drying agent (heated air) should be as high as the humidity of the sunflower seeds.

Drying of seeds in drum-type dryers is carried out in a layer of spilled seeds by blowing it with hot air. At the beginning of drying, the temperature of the drying agent, depending on the moisture content of the seeds, is kept at 250 - 350 °C, at the exit from the dryer – 50 - 80 °C. On average, drying sunflower seeds in drum dryers takes 15-20 minutes.

The disadvantage of using drum dryers is the partial destruction of the husk and the loss of seeds. Rigid drying regimes lead to uneven heating and overdrying of the seed, to an increase in its fat content.

Drum grain dryers when drying sunflower seeds are very fire-hazardous and do not allow obtaining seeds with uniform moisture content, and the use of high-temperature regimes leads to a decrease in the sowing qualities of seeds due to overheating [3, 4]. Recirculating dryers, unlike direct-flow dryers, allow you to dry seeds with different moisture content in one cycle. The technology of drying seeds in recirculation dryers with heating chambers in the falling layer consists in alternating short-term heating of seeds in an upward flow of hot air at a temperature of 250 - 350 °C laying of heated seeds, their cooling and recirculation. With this method, simultaneously with the drying of the seed, it is cleaned of weedy impurities. High-temperature drying of sunflower seeds in recirculating grain dryers has a positive effect on oil quality indicators. When seeds are heated in the dryer to 60...70 °C, the acid value decreases, and at lower heating temperatures (up to 50 °C) - a slight increase in the acid value of the oil. However, the acid value of the oil decreases at temperatures above 70 °C, and the decrease in this indicator is greater, the higher the seed heating temperature. But at higher temperatures of seed heating, there is an increase in injury due to overdrying of the fruit membrane.





When drying sunflower seeds in recirculation type dryers, it is very important to evenly distribute the seeds over the entire cross-section of the chamber, as well as to prevent the accumulation of oil dust in the heating chamber and to eliminate the ingress of sparks from the furnace into the heating chamber, since dryers of this type are fire-hazardous.

The advantage of drying seeds in ventilated bunkers is their simplicity and long service life. Soft drying modes prevent injury to sunflower seeds. However, this method of drying is much longer than others, and is characterized by uneven drying of the seeds. To avoid this, the fan must be periodically turned off, and the seeds should be thoroughly mixed.

With benzopyrin may occur. At the same time, it is noted that an increase in exposure to drying leads to a sharp increase in benzopyrin in sunflower seeds. Thus, when improving the technology and technical means of drying sunflower seeds, the processing products of which are food for humans, it is necessary to take into account the conditions for the entry of carcinogenic substances into the seeds and prevent their formation during the drying process.

At the same time, the developed drying equipment does not meet all the technological features of sunflower drying, both for seed purposes and for commercial production (obtaining oil) [1, 2, 4, 6]. In this regard, solving the problems of substantiation and development of technology, design and recommendations for drying equipment intended for drying sunflower seeds is one of the urgent tasks of the national economy. Its solution can guarantee the reduction of seed losses during post-harvest processing and ensure quality preservation of the material.

At the same time, increasing productivity, reducing the unevenness of drying and the risk of fire in drying plants, preserving the nutritional and sowing qualities of seeds with minimal energy consumption are important related tasks in solving this problem. The complexity of their implementation lies in the methodological lack of calculation of the necessary parameters that take into account the specific and technological properties of the mass of sunflower seeds (oiliness, fluidity and clogging).

---

### 3. Aim of the researches

---

The purpose of research. Research and substantiate the need for technological and technical proposals for the creation of drying vibration equipment.

---

### 4. Results of the researches

---

One of the promising methods of drying bulk materials is the method of drying in a vibrating fluidized bed, which can be achieved on vibrating dryers of various types. However, due to the relatively long drying time of some materials, the best are drying units created on the basis of vibrating conveyors, which, compared to other dryers, allow to significantly increase the time the material stays in one unit.

Vibrating fluidized bed can be created in devices of a wide variety of designs by impacting the bulk material of the vibrating bottom, walls or additional partitions, as well as with the help of special vibrators placed directly in the drying chamber or outside. The use of devices that create a vibrating fluidized bed makes it possible to improve the mixing of the material and thereby increase the value of heat and mass transfer coefficients several times.

Numerous studies have shown that the properties of a layer of loose material with an increase in the intensity of the vibration effect change significantly at the beginning of the separation of the parts from each other and from the vibrating surface on which these parts are located [5, 6, 7].

Initially, with an increase in the oscillating motion in the vibrating container, the layer is compacted, which reaches its maximum value at accelerations of 9,8-10 m/c<sup>2</sup>. With a further increase in  $a$ , the layer expands and in its condition resembles a boiling layer during its blowing by a gas flow.

In a vibrating fluidized bed, particles of the same size, but with different densities, are mixed. However, for a polydisperse material with the same density of particles, separation is observed with an increase in the content of significant particles in the upper part of the layer. Gas permeability mostly depends on the dispersion, humidity and height of the material layer. The amplitude and acceleration of the parts also affect the pressure drop  $y$  layers. With the same vibration accelerations, the lower the frequency, the greater the pressure drop in the material layer can be obtained.

The action of the vibration field makes it possible to simultaneously transport products in the working area and create a vibrating-boiling layer of material, and the technological impact is directed directly at the products being dried or at the gas environment in which they are located.





The basic design -technological diagram of a vibrating drying unit with IR emitters (Fig. 1.) consists of a drying vibrating chamber 9, a perforated grid 13, a vibrator 4, an IR emitter 12, a fan with an electric motor, a nozzle and a vibrating feeder [2].

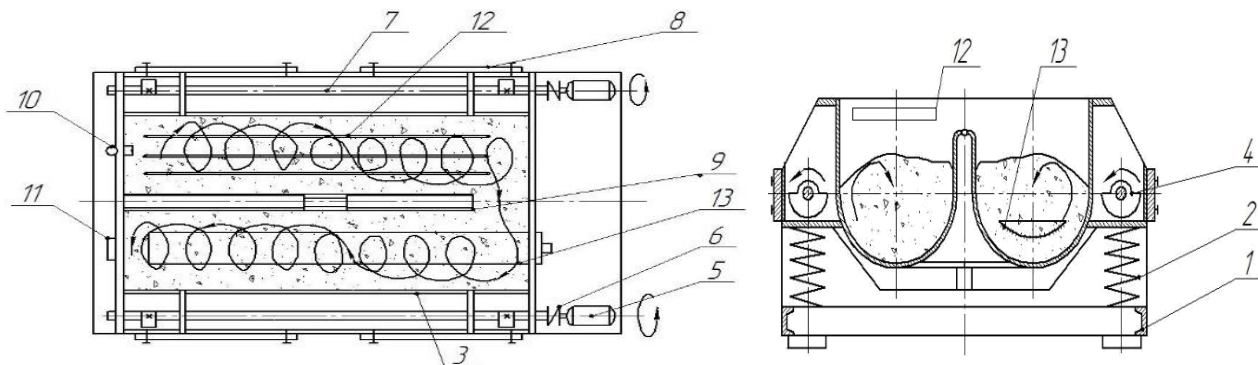

**Fig. 1. Design and technological scheme of the vibrating installation:**

**1 – frame; 2 – spring; 3 – container body; 4 – imbalances ; 5 – electric motor; 6 – coupling; 7 – unbalanced shaft; 8 – protective shields; 9 – dividing wall; 10 – loading neck; 11 – discharge neck; 12 – IR emitter; 13 – cold air supply nozzle.**

The working chamber had two U-shaped chutes 9, the chamber was attached to the frame by four springs 2. The vibrator consisted of two shafts 7 on which four imbalances were mounted, two of which were movable. The shafts were driven by direct current electric motors 5 through elastic couplings 6. The electric motors were connected to one control resistor, which ensured oscillation of the vibrating chamber along a circular trajectory.

The use of a U-shaped bottom and oscillations along a circular path ensures the helical movement of dispersed material during its intensive loosening, mixing and increasing the uniformity of drying along the height of the material layer. The material was fed into the first chute of the cylinder by an electromagnetic type vibratory feeder and exits from it through a nozzle with a latch that regulates the height of the outlet opening.

A number of experiments were conducted to substantiate the technological and technical proposals for the process of drying sunflower seeds and to determine the operating parameters of the dryer. Based on the results, graphs were constructed. The analysis of the curves (Fig. 2) showed that the drying time of the product from the initial moisture content of 18.9% to the final moisture content of 7%, at a distance from the IR emitter to the product layer of 25 mm, with a heat flux density of 5 kW/m<sup>2</sup>, with increasing height of the sunflower seed layer from 15 mm to 25 mm increases by 14 min, at a distance from the IR emitter to the product layer of 40 mm, increases by 13 min.

From the analysis of the curves (Fig. 3), it can be seen that the drying time of sunflower seeds from the initial humidity of 18,9% to the final humidity of 7%, for the height of the sunflower seed layer of 25 mm, the distance from the IR emitter to the product layer of 25 mm, with an increase in the heat flow density (the factor that most affects the drying time of sunflower seeds) from 3,64 to 5 kW/m<sup>2</sup> decreases for 15 min, for the height of the sunflower seed layer of 15 mm, the distance from the IR emitter to the product layer of 25 mm, with an increase in the heat flux density with 3,64 to 5 kW/m<sup>2</sup> decreases in 25 min

To determine the optimal drying modes, the minimum of the initial parameter was adopted as an optimization criterion, since the intensification of the drying process of sunflower seeds, taking into account the quality of the finished product, consists in minimizing the drying time.

The analysis of the results showed that the height of the layer of sunflower seeds in the dryer should be 15 mm, the distance from the IR emitter to the layer of sunflower seeds should be 25 mm, and the heat flux density of IR radiation should be 5 kW/m<sup>2</sup>.

From the analysis of the curves (Fig. 4), it can be seen that the moisture content of sunflower seeds during the entire drying process decreases over time according to a linear law. The rate of moisture removal at a heat flow density of 4,32 kW/m<sup>2</sup> is  $dU/dt = 0,50-0,55 \text{ \%/min}$ , at a heat flow density of 5 kW/m<sup>2</sup>,  $dU/dt = 0,95-1,00 \text{ \%/min}$  (Fig. 2), for a heat flow density of 3,64 kW/m<sup>2</sup>  $dU/dt = 0,33-0,38 \text{ \%/min}$  (Fig. 3). Thus, knowing the initial moisture content of sunflower seeds, it is possible to determine the drying time of the material to the final moisture content depending on the heat flux density at the selected optimal values of the height of the sunflower seed layer and the distance from the IR emitter to the product layer. These data can be used during the engineering calculation of the drying apparatus for sunflower seeds.

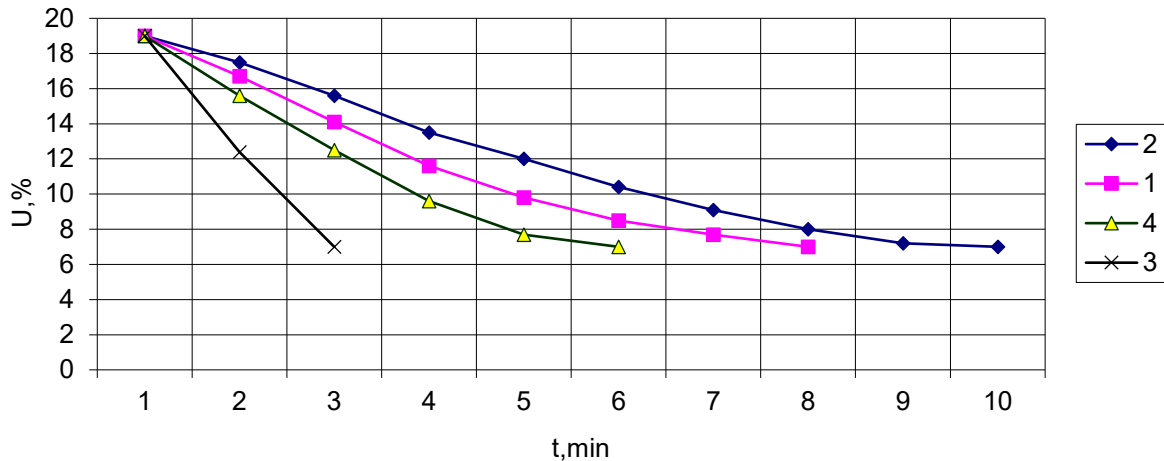

**Fig. 2.** Graph of the dependence of sunflower seed humidity on time for the height of the sunflower seed layer 15 mm (curve 1 and 3), 25 mm (curve 2 and 4), the distance from the IR emitter to the sunflower seed layer 40 mm (curve 1 and 2), 25 mm (curve 3 and 4) and for the heat flux density of the IR emitter of  $5 \text{ kW/m}^2$ .

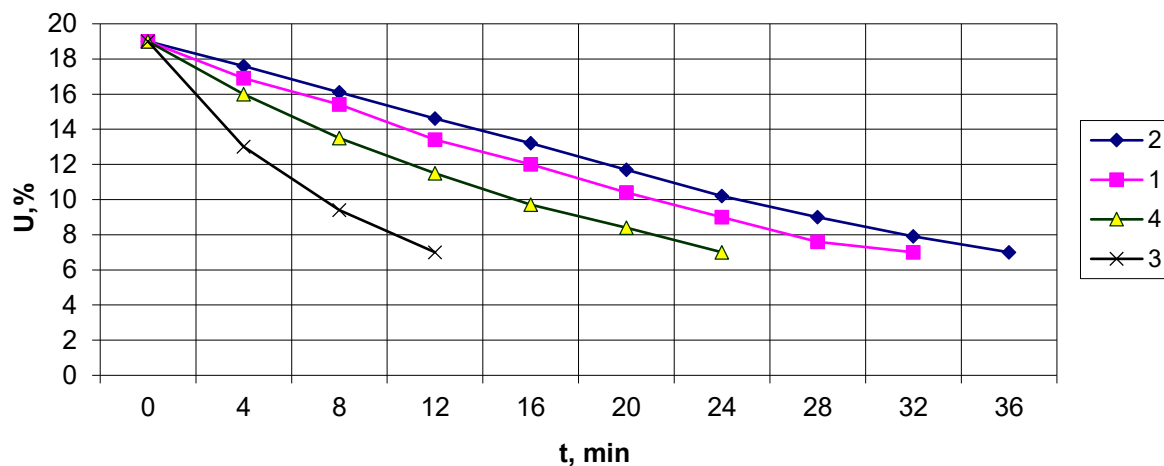

**Fig. 3.** Graph of the dependence of sunflower seed humidity on time for the height of the sunflower seed layer 15 mm (curve 1 and 3), 25 mm (curve 2 and 4), the distance from the IR emitter to the layer of sunflower seeds 25 mm and the heat flux density of the IR emitter  $3,64 \text{ kW/m}^2$  (curve 1 and 2) and  $5 \text{ kW/m}^2$  (curve 3 and 4).

A rapid increase in temperature in the center of the sunflower seed was noted over time (Fig. 5). The temperature on the surface of sunflower seeds also rises, but somewhat more slowly. Thus, a temperature gradient occurs in the material. Figure 5 shows that during the entire drying process, the temperature difference between the center and the surface of the seed remains constant and amounts to 4-5 °C.

During infrared drying of sunflower seeds with a wavelength of 1.5 - 3.0  $\mu\text{m}$ , the directions of moisture movement coincide both as a result of moisture conductivity and thermal moisture conductivity.

The performance of infrared emitters with a wavelength of 1.5-3.0 microns is determined by the fact that it corresponds to the frequency of natural oscillations of the water molecule in the seed nucleus, which during irradiation is selectively heated and resonantly evaporates.

Mathematical processing of experimental data makes it possible to conclude that the heat flux density factor of IR radiation has the greatest influence on the drying process. The next most important factor is the initial moisture content of sunflower seeds. The influence of factors such as the height of the seed layer and the distance from the IR emitter to the sunflower seed layer is insignificant and approximately the same.

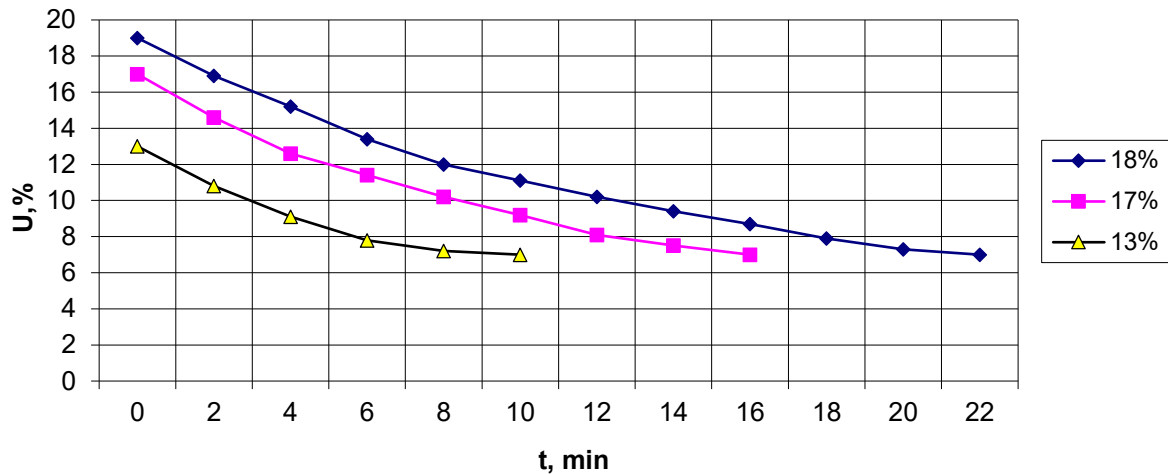
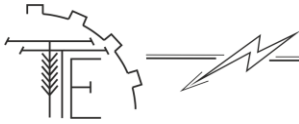

**Fig. 4.** Graph of the dependence of sunflower seed humidity on time for the height of the sunflower seed layer of 15 mm, the distance from the IR emitter to the sunflower seed layer of 25 mm, and the heat flux density of the IR emitter of  $4,32 \text{ kW/m}^2$ .

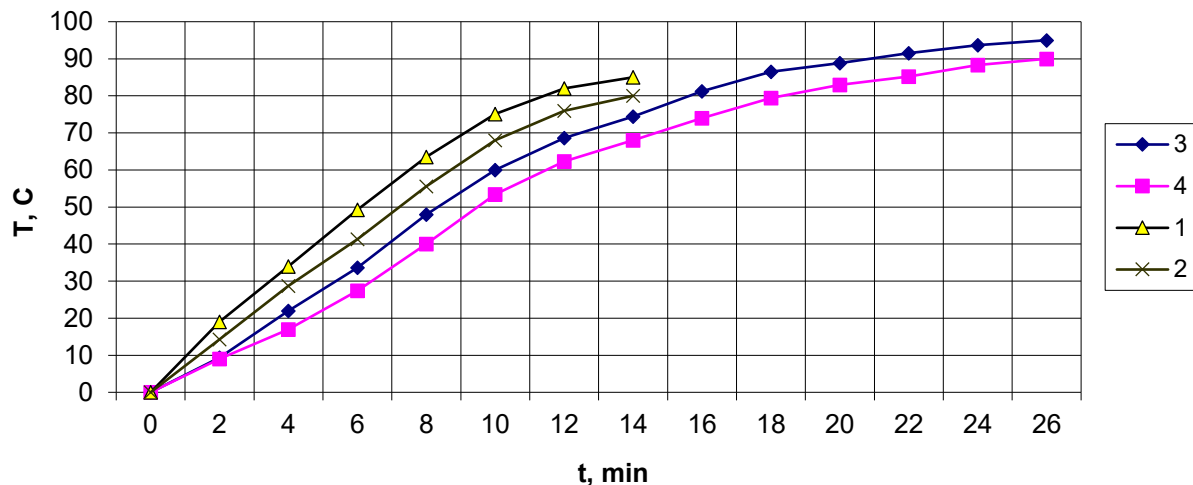

**Fig. 5.** Temperature curves of the drying process of sunflower seeds with a height of the product layer in the dryer of 15 mm, the distance from the IR emitter to the seed layer of 25 mm, the heat flux density of IR radiation -  $5 \text{ kW/m}^2$ ; 1 – the initial moisture content of the core is 16%; 2 – initial surface moisture 16%; 3 – the initial moisture content of the core is 19%; 4 – initial surface humidity of 19%.

During the infrared drying of sunflower seeds, the movement of tightly bound moisture from the colloidal core of the seed to the surface of the wet shell with open pores occurs, and then the intensive removal of weakly bound surface moisture from the capillary-porous shell occurs. During drying, there is no cracking of the seed coat, which has high hygroscopicity and moisture, which is twice the moisture of sunflower seeds, and which serves as mechanical protection against the action of microorganisms, organic weedy impurities. The porous shell of the seed remains moist because the moisture that evaporates from the inside (during the movement from a hotter body to a less heated one) is freely removed to the atmosphere through the open pores.

## 5. Conclusions

The results of the research proved the expediency and necessity of using vibrating dryers during drying of sunflower seeds, and it was established that during IR drying with a wavelength of  $1,5 - 3,0 \mu\text{m}$ , the moisture content of the product during the entire drying process decreases over time according to a linear law, with this coincides with the directions of moisture movement both as a result of moisture conductivity and thermal moisture conductivity. During drying, the seed coat does not crack. The best parameters of the infrared





radiation drying process were found with a selected wavelength of 1,5-3,0  $\mu\text{m}$ , a sunflower seed layer height of 15 mm, a heat flux density of IR radiation of 5  $\text{kW/m}^2$ , and the height of the IR generator blocks relative to the layer of the irradiated product. - 25 mm, while the drying time will be 11 minutes.

### References

- [1] Palamarchuk, I.P., Bernyk, P.S., Stotsko, Z.A., Yaskov, V.V., Zozulyak, I.A. (2006). *Heat and mass exchange processes and equipment of processing and food production : training*. Lviv : "Beskid Bit" Publishing House. [in Ukrainian].
- [2] Zozulyak, I.A. (2020). Justification structural and technological parameters of the infrared vibrating dryer. *Technology, energy and transport of the agricultural industry, 1 (108)*. 75–81. DOI: 10.37128/2520-6168-2020-1-9. [in Ukrainian].
- [3] Zozulyak, I.A. (2014). Priming the structure of the vibrating machine for drying granular and granular materials. *Similar European Journal of Advanced Technologies, 1/7 (67)*. 15–19. [in Ukrainian].
- [4] Bandura, V., Zozuliak, I., Palamarchuk, V. (2014). Description of heat exchange in the similarity theory of vibrating drying process of sunflower. *Ukrainian Journal of Food Science, 2(2)*. 305–311. [in English].
- [5] Burdo, O., Bandura, V., Zykov, A., Zozulyak, I., Levtrinskaya, J., Marenchenko, E. (2017). Using of the wave technologies in intensification processes of heat and mass transfer. *EUREKA: Physics and Engineering, 4*. 18–24. DOI: 10.21303/2461-4262.2017.00399. [in English].
- [6] Paziuk, V.M., Petrova, Z.O., Tokarchuk, O.A., Yaropud, V.M. (2019). Research of rational methods of drying rape seed. *INMATEH-Agricultural Engineering, 58 (2)*. 303–310. [in English].
- [7] Paziuk, V.M., Liubin, M.V., Yaropud, V.M., Tokarchuk, O.A., Tokarchuk, D.M. (2018). Research on the rational regimes of wheat seeds drying. *INMATEH-Agricultural Engineering, 56(3)*. 39–48. [in English].
- [8] Burdo, O.G., Bandura, V.N., Levtrinskaya, Yu.O. (2018). Electrotechnologies of targeted energy delivery in the processing of food raw materials. *Surface Engineering and Applied Electrochemistry, 54 (2)*. 210–218. [in English].

### Список використаних джерел

1. Паламарчук І. П., Берник П. С., Стоцько З. А., Яськов В. В., Зозуляк І. А. Тепломасообмінні процеси та обладнання переробного та харчового виробництва : навч. посіб. Том 2. Львів: Видавництво „Бескид Біт”, 2006. 368 с.
2. Зозуляк І. А. Обґрунтування конструкційно-технологічних параметрів інфрачервоної вібраційної сушарки. *Техніка, енергетика та транспорт АПК*. 2020. № 1 (108). С. 75–81. DOI: 10.37128/2520-6168-2020-1-9
3. Зозуляк І. А. Обґрунтування конструкції вібромашини для сушіння гранульованих і зернистих матеріалів. *Східно-європейський журнал передових технологій*. 2014. № 1/7 (67). С. 15–19.
4. Bandura V., Zozuliak I., Palamarchuk V. Description of heat exchange in the similarity theory of vibrating drying process of sunflower. *Ukrainian Journal of Food Science*. 2014. Vol. 2, № 2. P. 305– 311.
5. Burdo O., Bandura V., Zykov A., Zozulyak I., Levtrinskaya J., Marenchenko E. Using of the wave technologies in intensification processes of heat and mass transfer. *EUREKA: Physics and Engineering*. 2017. Vol. 4. P. 18–24. DOI: 10.21303/2461-4262.2017.00399
6. Paziuk V. M., Petrova Z. O., Tokarchuk O. A., Yaropud V. M. Research of rational modes of drying rape seed. *INMATEH-Agricultural Engineering*. 2019. Vol. 58, № 2. P. 303–310.
7. Paziuk V. M., Liubin M. V., Yaropud V. M., Tokarchuk O. A., Tokarchuk D. M. Research on the rational regimes of wheat seeds drying. *INMATEH-Agricultural Engineering*. 2018. Vol. 56, № 3. P. 39– 48
8. Burdo O. G., Bandura V. N., Levtrinskaya Yu. O. Electrotechnologies of targeted energy delivery in the processing of food raw materials. *Surface Engineering and Applied Electrochemistry*. 2018. Vol. 54. № 2. P. 210–218.

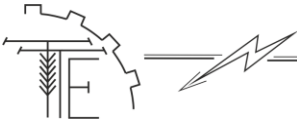
**МОДЕЛЮВАННЯ ПРОЦЕСУ ВІБРАЦІЙНОГО СУШІННЯ СОНЯШНИКУ**

Цю роботу присвячено дослідженню й обґрунтуванню технології сушіння насіння соняшнику та розробленню технологічних і технічних пропозицій зі створення сушильної техніки, яка б забезпечувала роботу на цій культурі, як у насінневому, так і в продовольчому режимах.

Технологічна цінність насіння соняшнику визначається його олійністю. Тому важливо зберегти кількість і якість олії. За оптимальних режимів сушіння вміст олії в насінні соняшнику збільшується. Тому виникає питання підбору технологічного обладнання для проведення процесу сушіння.

Аналіз механіко-технологічних параметрів сушарок, що серійно випускаються, показав, що ці машини призначені, в основному, для обробки зернових культур. Недоліками відомих шахтних зерносушарок є низьке вологознімання за один пропуск матеріалу через сушарку, перегрів насіння і зниження його якості в зоні контакту з поверхнею підвідних коробів, підвищена пожежонебезпека. Барабанні зерносушарки при сушінні насіння соняшнику вельми пожежонебезпечні та не дають змоги отримувати однорідне за вологістю насіння, а використання високотемпературних режимів призводить до зниження посівних якостей насіння від перегріву. Під час висушування насіння соняшнику в сушарках рециркуляційного типу дуже важливо рівномірно розподіляти насіння по всьому перерізу камери, а також не допускати скупчення олійного пилу в камері нагрівання та усувати потрапляння іскор із топки в камеру нагрівання. Одним із перспективних способів сушіння сипучих матеріалів є спосіб сушіння у віброкиплячому шарі, який може бути досягнутий на вібраційних сушарках різного типу.

Для обґрунтування технологічних і технічних пропозицій процесу сушіння насіння соняшнику та визначення режимних параметрів роботи сушарки було проведено ряд експериментів. По результатах яких було побудовані графіки. Результати досліджень засвідчили доцільність і необхідність використання вібраційних сушарок під час сушіння насіння соняшнику. Знайдено найкращі параметри процесу сушіння інфрачервоним випромінюванням із виділеною довжиною хвилі 1,5-3,0 мкм., висотою шару насіння соняшнику 15 мм, густиною теплового потоку ІЧ-випромінювання 5 кВт/м<sup>2</sup>, висотою розміщення блоків ІЧ-генераторів відносно шару опромінюваного продукту – 25 мм, при цьому час сушіння буде становити 11 хв.

**Ключові слова:** соняшник, сушіння, сушарка, вологість, контейнер, електродвигун, коливання, вібрація.

**Рис. 5. Літ. 8.**

**INFORMATION ABOUT THE AUTHORS**

**Igor Zozulyak** – Candidate of Technical Sciences, Senior Lecturer of the Technological Department Processes and Equipment Processing and Food Productions Vinnytsia of the National Agrarian University (3, Solnyshchaya St., Vinnytsia, 21008, Ukraine, e-mail: zozulak@vsau.vin.ua, [https:// orcid.org /0000-0002-5381-3115](https://orcid.org/0000-0002-5381-3115)).

**Зозуляк Ігор Анатолійович** – кандидат технічних наук, старший викладач кафедри технологічних процесів та обладнання переробних і харчових виробництв Вінницького національного аграрного університету (вул. Сонячна, 3, м. Вінниця, 21008, Україна, e-mail: zozulak@vsau.vin.ua, <https://orcid.org/0000-0002-5381-3115>).