



Всеукраїнський науково-технічний журнал

Ukrainian Scientific & Technical Journal

ISSN 2306-8744

DOI: 10.37128/2306-8744-2023-1

Вібрації в техніці та технологіях

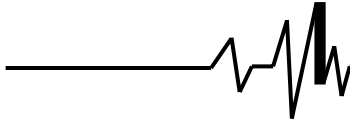

**ВІБРАЦІЇ В
ТЕХНІЦІ ТА
ТЕХНОЛОГІЯХ**

Журнал науково-виробничого та навчального
спрямування Видавець: Вінницький національний
аграрний університет

Заснований у 1994 році під назвою “Вібрації в техніці та
технологіях”

*Свідоцтво про державну реєстрацію засобів масової
інформації*

КВ № 16643-5115 ПР від 30.04.2010 р.

*Всеукраїнський науково-технічний журнал “Вібрації в техніці та
технологіях” / Редколегія: Калетнік Г.М. (головний редактор) та інші. – Вінниця,
2023. – 1 (108) – 109 с.*

*Друкується за рішенням Вченої ради Вінницького національного аграрного
університету (протокол № 6 від 01.05.2023 р.)*

*Періодичне видання включено до Переліку наукових фахових видань
України з технічних наук (Категорія «Б» Наказ Міністерства освіти і науки
України від 02.07.2020 р. № 886)*

Головний редактор

Калетнік Г.М. – д.е.н., професор,
академік НААН України, Вінницький
національний аграрний університет

**Заступник головного
редактора**

Адамчук В.В. – д.т.н., професор, академік
НААН України, Національний науковий
центр “Інститут механізації та електрифікації
сільського господарства”

Відповідальний секретар

Солона О.В. – к.т.н., доцент, Вінницький
національний аграрний університет

Члени редакційної колегії

Булгаков В.М. – д.т.н., професор, академік
НААН України, Національний університет
біоресурсів і природокористування України

Граняк В.Ф. – к.т.н., доцент, Вінницький
національний аграрний університет

Деревенько І. А. – к.т.н., доцент,
Національний університет «Львівська
політехніка»

Зіньковський А.П. – д.т.н., професор,
Інститут проблем міцності імені Г. С.
Писаренка НАН України

Купчук І.М. – к.т.н., доцент, Вінницький
національний аграрний університет

Матвєєв В.В. – д.ф.-м.н., професор,
академік НАН, Інститут проблем міцності
імені Г.С. Писаренка НАН України

Полєвода Ю.А. – к.т.н., доцент, Вінницький
національний аграрний університет

Матвійчук В.А. – професор, Вінницький
національний аграрний університет

Твердохліб І.В. – к.т.н., доцент, Вінницький
національний аграрний університет

Токарчук О.А. – к.т.н., доцент, Вінницький
національний аграрний університет

Цуркан О.В. – д.т.н. доцент, Вінницький
національний аграрний університет

Зарубіжні члени редакційної колегії

Максімов Джордан Тодоров – д.т.н., проф., Технічний Університет Габрово (Болгарія)

Технічний редактор **Мельничук С.В.**

Адреса редакції: 21008, Вінниця, вул. Сонячна 3, Вінницький національний аграрний
університет, тел. 46 – 00– 03

Сайт журналу: <http://vibrojournal.vsau.org/>

Електронна адреса: vibration.vin@ukr.net

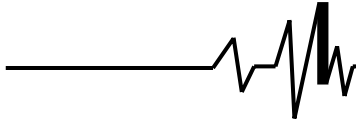
**З М І С Т****1. ТЕОРІЯ ПРОЦЕСІВ ТА МАШИН***Калетнік Г.М., Яропуд В.М., Солоня О.В.,***РЕКОМЕНДАЦІЇ ЩОДО КОНСТРУЮВАННЯ АДАПТИВНОГО ВІБРАЦІЙНОГО МЛИНА У ТЕХНОЛОГІЇ ПРИГОТУВАННЯ КОНЦЕНТРОВАНИХ КОРМІВ.....5***Бовсуновський А.П.***ДОСЛІДЖЕННЯ ПРОЦЕСУ РОСТУ КРУГОВОЇ ТРИЩИНИ ПРИ КРУТИЛЬНИХ КОЛИВАННЯХ ВАЛОПРОВОДУ ПАРОВОЇ ТУРБИНИ.....16***Пономаренко Н. О., Волик Б. А., Дімітров І. І.***АНАЛІЗ МЕХАНІЗМУ ЗБУДЖЕННЯ КОЛИВАНЬ РОБОЧИХ ОРГАНІВ ДИСКАТОРА З ОБЕРТАННЯМ НАВКОЛО ОСІ КРІПЛЕННЯ.....29***Алієв Е. Б., Лугко К. О..***МЕТОДИКА СИМУЛЯЦІЇ ПРОЦЕСУ СЕПАРАЦІЇ НАСІННЄВОГО МАТЕРІАЛУ ДРІБНОНАСІННЄВИХ КУЛЬТУР НА ЦИЛІНДРИЧНОМУ ЧАРУНКОВОМУ ТРІЄРІ36***Спірін А. В., Цуркан О. В., Твердохліб І. В., Борисюк Д. В.***ВПЛИВ ВІБРАЦІЇ НА ЕРГОНОМІЧНІ ПОКАЗНИКИ ВИРОБНИЧОГО ПРОЦЕСУ45****2. МАШИНОБУДУВАННЯ ТА МАТЕРІАЛООБРОБКА***Веселовська Н.Р., Шаргородський С.А., Бурлака С.А.***МАТЕМАТИЧНЕ МОДЕЛЮВАННЯ ВЗАЄМОДІЇ СТІЛЧАСТОЇ ЛАПИ КУЛЬТИВАТОРА З ГРУНТОМ.....57***Matviychuk V., Mikhalevich V., Shtuts A.***ANALYSIS OF STRESS-STRAIN STATE (SSS) OF BILLET MATERIAL IN THE COURSE OF SETTING BY RESOURCE-SAVING METHOD OF ROLL STAMPING.....63***Яропуд В.М., Дацюк Д.А., Теслюк Г.В.***ВИКОРИСТАННЯ МЕТОДУ ДИСКРЕТНИХ ЕЛЕМЕНТІВ У МОДЕЛЮВАННІ РУХУ ТА УКЛАДАННЯ НАСІННЯ ДРІБНОНАСІННЄВИХ КУЛЬТУР73***Shargorodskiy S., Rutkevych V.***DEVELOPMENT OF THE MATHEMATICAL MODEL OF THE VOLUME HYDROSTATIC TRANSMISSION HST-112 IN THE BRAKING MODE.....83***Полєвода Ю. А., Рєва В. Ю., Твердохліб І.В.***ОСОБЛИВОСТІ ПРОЦЕСУ МІКРОНІЗАЦІЇ ЗЕРНА.....92***Залізняк Р.О.***МОДЕЛЮВАННЯ І УДОСКОНАЛЕННЯ АНІЗОТРОПНОГО ЗМІЦНЕННЯ ОРТОТРОПНИХ КРИШТАЛЕВИХ МАТЕРІАЛІВ.....99***Trukhanska O.***INVESTIGATION THE IMPACT OF THE CONSTRUCTIVE PARAMETERS OF THE WORKING BODY THE TILLAGE MACHINE ON THE ENERGY INTENSITY AND QUALITY OF SOILTILLAGE104**

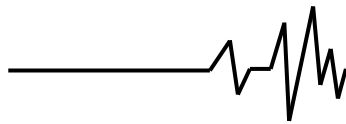
**Matviychuk V.**doctor of Technical Sciences, Full
Professor**Mikhalevich v.**doctor of Technical Sciences, Full
Professor**Shtuts A.**

assistant

**Vinnitsia National Agrarian
University****Матвійчук В. А.**

доктор технічних наук, професор

Михалевич В. М.

доктор технічних наук, професор

Штуць А. А.

асистент

**Вінницький національний
аграрний університет****UDC 621.77.01****DOI: 10.37128/2306-8744-2023-1-7****ANALYSIS OF STRESS-STRAIN
STATE (SSS) OF BILLET
MATERIAL IN THE COURSE OF
SETTING BY RESOURCE-SAVING
METHOD OF ROLL STAMPING**

The processes of planting blanks by the rolling stamping method allow for the efficient production of a wide range of high-quality products, but the possibility of material destruction during deformation prevents the expansion of their technological capabilities. Further development of the processes is possible through the development of new technological schemes based on the analysis of deformation kinematics and the appointment of favorable technological parameters, taking into account their influence on the stress-strain state and deformability of the material of the workpieces. In order to widely use the method of assessing the deformability of workpieces, a reliable technique is needed, which provides for the presence of a mathematical model of the trajectory of deformation of material particles in the coordinates "stress state indicator - accumulated plastic deformation before failure." The work uses an approach to finding an analytical representation of the deformation trajectory based on the construction of a differential equation between the components of plastic deformation increments, followed by the solution of this equation and the identification of its parameters based on experimental data. According to the results of the research, the deformation trajectories of the material particles of the peripheral surface of the flange when planting by rolling stamping method were schematically constructed in the coordinates "intensity of deformations - stress state indicator". Based on the built model, damage accumulation can be simulated by changing the values of the model parameters for different materials and deformation paths. An analytical representation of the deformation trajectory in a parametric form was obtained. The advantages of representing the deformation trajectory in the form of parametric equations are the convenience of analyzing these trajectories. The advantage of the model of the trajectory of deformation of material particles in the coordinates "stress state indicator - plastic strain accumulated before failure" is the absence of a material constant in the analytical expression for the stress state, and the consequence is additional convenience of analyzing ratios and selecting the value of the material constant based on experimental data.

Key words: rolling stamping, flange landing, stress-strain state, mathematical model of the deformation trajectory..

Formulation of the problem. Information about the stress-strain state (SSS) of the workpiece material and the influence of various technological parameters on it is especially important when developing rolling stamping processes (RSP). On the basis of such

information, it is possible to determine the force parameters of the process, evaluate the deformability of the material of the workpieces and the stability of the tooling, purposefully expand the technological capabilities of the process, and predict the service characteristics of the products



[1]. One of the most widespread RSP operations is planting, during which only part of the workpiece is deposited. It is possible to obtain complex profiled products with developed thin-walled elements with high precision by planting. At the same time, due to the achievement of significant deformations, there is a risk of destruction of the workpiece material due to its insufficient deformability [2, 3]. A variety of methods are used for the study of SSS in OMD processes: experimental, analytical, and simulation modeling. Combined experimental and computational methods have proven themselves to be the best in terms of accuracy and efficiency. All of the above determines the urgency of conducting a study of the SSS of the material of the blanks when planting by the RSP method.

Analysis of Recent Research and Publications. Process flow diagrams of outer flange setting on pipe billets using conical roll are shown in fig. 1. As follows from research [2], the

kinematics of billet material flow and, accordingly, the SSS of the material significantly depend on mutual location of the roll and the billet. From the viewpoint of destruction, flange's external free side surface was the most dangerous one. Where the position of the roll top coincides with billet's axis (Fig. 1a), the material flow occurs both towards the axis and in the centrifugal direction, which is the predominant one. In case of material flow limitation to the axis using an internal mandrel, the material will be squeezed between the roll and the mandrel. The form of such a billet is shown in fig. 2, a. As the roll top shifts in the direction of the contact spot, as shown in Fig. 1, b, the intensity of material flow from the billet axis increases. This displacement contributes to the centrifugal material flow and to departure of billet flange's peripheral part from the contact with the roll, as can be seen in fig. 2, b.

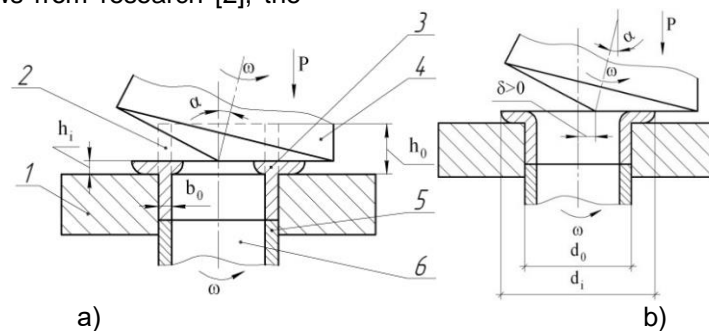

Fig. 1. Process flow diagrams of billet's outer flange setting using the rolling stamping method depending on the position of the roll top: a) without its displacement from the billet axis, b) with displacement in the direction of the contact spot.



a)



b)

Fig. 2. The view of billet flanges obtained by setting using RSP method according to the diagrams in fig. 1,a and 1,b – respectively

Papers [2, 3] represent various studies of material's SSS in the pipe billet's flange area. Fig. 3 shows the nature of stress intensity distribution $\sigma_u = const$ and strain intensity $\varepsilon_u = const$, as obtained by hardness measurement method, with Fig. 4 showing deformation intensities, as obtained using the finite element method (FEM) and Fig. 5

showing a fragment of the original grid on the pipe billet surface.

In paper [4], the paths of strain of material particles of the flange's free surface were obtained using the grids method within the coordinates of the stress state indicator – the deformation intensity.

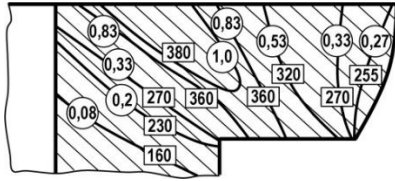
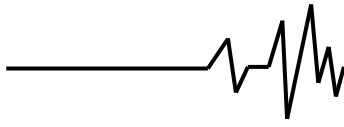

Fig. 3. The nature of distribution within flange cross-section with $\bar{\epsilon}_i = const$ (O), $\sigma_i = const$ (□) parameters

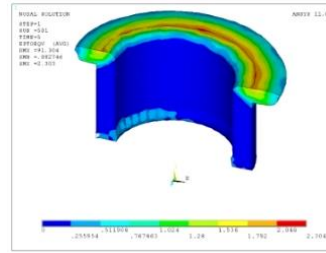

Fig. 4. $\bar{\epsilon}_i = const$ distribution within flange section

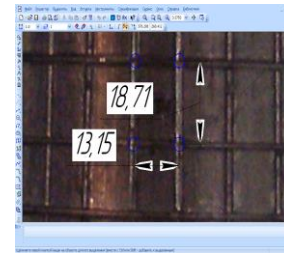

Fig. 5. Fragment of the original grid on the pipe billet surface

Since process capabilities of the operation under research may significantly be limited due to formation of cracks on the side surface during RSP, the said processes should be developed together with generation and study of material deformability model for specified dangerous zones of the billets.

One of the elements of billet material deformability model in plastic deformation processes is the mathematical model of material particles' deformation trajectory in the coordinates of the "stress state indicator" – pre-failure accumulated plastic deformation" [5]. Studies have shown that the most effective approach would be to find an analytical representation of the deformation trajectory based on construction of a differential equation between the components of plastic deformation increments to be followed by solution of this equation and identification of its parameters based on experimental data. Of course, the effectiveness of this approach significantly depends on the degree of reasonableness of choice of the original differential equation.

Research Purpose and Objectives. The purpose of this paper is to determine the stress state indicator using experimental-and-analytical method and to construct the deformation trajectory on the billet flange's free surface in the course of setting operation using the rolling stamping method.

Main Results of the Research. Let us consider the main elements of the analytical part of the said experimental-and-analytical approach [6, 7, 8]. Let's write down the relationship between axial ϵ_z and circular ϵ_ϕ logarithmic deformations of the billet material's macroparticle:

$$\epsilon_z = \epsilon_z(\epsilon_\phi) \quad (1)$$

Considered in [7, 8] is the side surface of a cylindrical sample under end compression, and the conditions for construction of this dependence in the form of a differential equation are formulated.

Based on these results, we formulate the conditions for construction of a similar dependence describing the change in deformed state of the

billet flange's free surface in the course of setting operation using the RSP method:

- The following structure of the 1st order nonlinear differential equation with separable variables is proposed:

$$\frac{d\epsilon_z}{d\epsilon_\phi} = \epsilon_z(\epsilon_\phi); \quad (2)$$

- it is believed that, at the initial moment of deformation, the material's stressed state can be stiffer than uniaxial compression's stressed state:

$$\frac{d\epsilon_z}{d\epsilon_\phi}(\epsilon_\phi = 0) = -(1 + \theta), 0 \leq \theta \leq 1; \quad (3)$$

- it is also believed that, when the deformation rises to an arbitrarily large value, the material's stressed state 4 approaches to an uniaxial tension:

$$\lim_{\epsilon_\phi \rightarrow \infty} \frac{d\epsilon_z}{d\epsilon_\phi} \geq -\frac{1}{2}; \quad (4)$$

- due to the phenomenon of gradual transition from of the side surface's cylindrical shape to a barrel shape with the increase of circular deformation value ϵ_ϕ , in connection with barrel formation development on the side surface, the ratio of increments of axial ϵ_z and circular ϵ_ϕ deformations increases (with absolute value decreasing), that is:

$$\frac{d\left(\frac{d\epsilon_z}{d\epsilon_\phi}\right)}{d\epsilon_\phi} = \frac{d^2\epsilon_z}{d\epsilon_\phi^2} \leq 0; \quad (5)$$

- the condition of the smallest possible number of parameters;
- the condition of the differential equation's integrability and low computational



complexity of solving the problem of limit deformations determination;

- the structure of the differential equation should be such that its solution in the parametric form would have the following form:

$$\begin{cases} \eta = \eta(t); \\ \bar{\varepsilon}_i = m \cdot f(t). \end{cases} \quad (6)$$

It should be noted that, with $\theta = 1$ condition (3) becomes identical to the similar condition formulated by the authors of [7, 8] for the process of cylindrical sample's end compression:

$$\frac{d\varepsilon_z}{d\varepsilon_\varphi}(\varepsilon_\varphi = 0) = -2. \quad (7)$$

With further implementation of the flow theory, it will be shown that this condition corresponds to the stress state of uniaxial compression:

$$\eta(\varepsilon_\varphi = 0) = -1. \quad (8)$$

The last condition means that regardless of the friction conditions at the cylindrical sample's ends at the initial stage of end compression, the material of the free side surface remains in a stressed state of uniform compression.

As regards the RSP pattern, where the conical roll's top can be displaced from the billet axis in the direction of the contact spot (Fig. 1, d), we would have a slightly different situation. This pattern makes it possible to obtain wide flanges, but already at the initial stages of rolling, the flange's peripheral zone departs from contact with the roll, this forming quite a rigid stress state pattern on the free surface. Therefore, at the initial stage of the specified process already, the material's more rigid stress state may occur in the dangerous zones, as compared to cylindrical samples' end compression.

Taking into account a number of formulated conditions, the following differential equation was constructed:

$$\frac{d\varepsilon_z}{d\varepsilon_\varphi} = -\frac{3}{4} \cdot (2 - \theta) \cdot \left(\frac{1}{3} + \frac{m^2}{\varepsilon_\varphi^2 + m^2} \right), m > 0, 0 \leq \theta \leq 1 \quad (9)$$

Numerical values of m, θ parameters are normally determined based on the results of measurements of changes in the coordinate grid's dimensions. Since this is related to appreciable scattering of such experimental data, it is necessary to first find the analytical form of dependence (1). In other words, we need to find a partial solution of the differential equation that would satisfy the following condition:

$$\varepsilon_z(\varepsilon_\varphi = 0) = 0. \quad (10)$$

We have an ordinary 1st order differential equation with separable variables (9). Let's separate the variables and integrate the both parts of the resulting equation:

$$\varepsilon_z = -\frac{3}{4} \cdot \int_0^{\varepsilon_\varphi} (2 - \theta) \cdot \left(\frac{1}{3} + \frac{m^2}{\varepsilon_\varphi^2 + m^2} \right) \cdot d\varepsilon_\varphi, \quad (11)$$

Having found the defined integral, we will finally obtain:

$$\varepsilon_z = -\frac{3}{4} \cdot (2 - \theta) \cdot \left(\frac{1}{3} \cdot \varepsilon_\varphi + m \cdot \arctg\left(\frac{\varepsilon_\varphi}{m}\right) \right). \quad (12)$$

Upon obtaining the analytical dependence for description of the change in the deformed state, we'll proceed to determination of the stress state indicator and construction of the deformation trajectory on the billet flange's free surface during the setting operation using the RSP method.

The stress state in the billet's dangerous part will be determined using the method detailed in [7, 8].

According to the flow theory relations, we will get:

$$s_{ij} = \frac{2}{3} \times \frac{s_i}{de_i} \times de_{ij}, \quad (13)$$

where s_{ij} are stress deviator components,

$$s_{ij} = s_{ij} - s; \quad (14)$$

σ is the first invariant of the stress tensor or the average stress:

$$s = \frac{s_{ii}}{3}; \quad (15)$$

$\sigma_1, \sigma_2, \sigma_3$ are main stresses s_{ij} ,

de_{ij} being the components of stress tensors and increments of plastic deformations, respectively;

$\sigma_i, \overline{de}_i$ are stress intensities and strain increments, respectively;

$$\sigma_i = \frac{1}{\sqrt{2}} \cdot \sqrt{(\sigma_z - \sigma_\varphi)^2 + (\sigma_\varphi - \sigma_r)^2 + (\sigma_r - \sigma_z)^2} \quad (16)$$

$$\overline{de}_i = \sqrt{(de_j)^2 + \frac{1}{3} \times (de_r - de_z)^2}; \quad (17)$$

$d\varepsilon_r$ is the increase in radial deformation.

The increment in radial deformation $d\varepsilon_r$ is determined from the condition of incompressibility:

$$d\varepsilon_z + d\varepsilon_\varphi + d\varepsilon_r = 0. \quad (18)$$

It should be noted that in the context of the methodology used, the definition of the stress

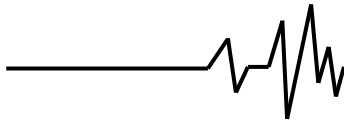

state means the definition of the stress state indicator:

$$\eta = \frac{\sigma_z + \sigma_\varphi + \sigma_r}{\sigma_i} \quad (19)$$

As can be seen from recent research papers [9], this indicator has been widely used not only in national literature [10], but also in the papers by researchers from far-abroad countries. In addition, it was shown that over the past decades, the number of papers in which this indicator is used to predict the destruction of materials under plastic deformation conditions has been steadily increasing.

The key aspect of the ability to determine the stress state indicator on the free side surface is the fact that the radial stress component is equal to zero $s_r = 0$.

Proceeding from this condition, expression (16) for the stress intensity takes the following form:

$$\sigma_i = \frac{1}{\sqrt{2}} \cdot \sqrt{(\sigma_z - \sigma_\varphi)^2 + (\sigma_\varphi)^2 + (\sigma_z)^2} \quad (20)$$

Based on the flow theory, we get [7, 8]:

Let's write down the expression for the stress state indicator based on (23) and taking into account (9):

$$h = \frac{\sqrt{3} \cdot (q - 2) + \frac{3 \cdot m^2}{e_j^2 + m^2} + 4 \cdot \frac{\ddot{\theta}}{\theta}}{\sqrt{12 + (q - 2) + \frac{3 \cdot m^2}{e_j^2 + m^2} + 2 \cdot \frac{\ddot{\theta}}{\theta}}}, \quad \{e_j, m\} \hat{\in} [0, \infty), q \hat{\in} [0, 1] \quad (24)$$

and analyze the obtained ratio. Since obtaining this ratio and its analysis are associated with elementary but rather cumbersome transformations, we will use the system of computer mathematics.

In a separate case, with $\theta = 0$ the last relation is transformed into the following expression:

$$h(q = 0) = \frac{1 - \frac{3 \cdot m^2}{e_j^2 + m^2}}{\sqrt{1 + 3 \cdot \frac{m^2}{e_j^2 + m^2}}}, \quad \{e_j, m\} \hat{\in} [0, \infty) \quad (25)$$

obtained by the authors of [7, 8]. At the initial moment of deformation at $\varepsilon_\varphi = 0$, the following is obtained from this ratio:

$$h(q = 0, e_j = 0) = -1 \quad (26)$$

$$s_z = \frac{2}{3} \cdot s_u \times \frac{2 \frac{de_z}{de_j} + 1}{\sqrt{1 + \frac{1}{3} \cdot 2 \frac{de_z}{de_j} + \frac{\ddot{\theta}}{\theta}}} \quad (21)$$

$$s_j = \frac{2}{3} \cdot s_u \times \frac{2 + \frac{de_z}{de_j}}{\sqrt{1 + \frac{1}{3} \cdot 2 \frac{de_z}{de_j} + \frac{\ddot{\theta}}{\theta}}} \quad (22)$$

$$h = \frac{2 \cdot \frac{de_z}{de_j} + \frac{\ddot{\theta}}{\theta}}{\sqrt{1 + \frac{1}{3} \cdot 2 \frac{de_z}{de_j} + \frac{\ddot{\theta}}{\theta}}} \quad (23)$$

An important feature of the applied methodology for determination of the material's stress-strained state is that numerical values of the average stress and stress intensity remain undefined. However, in order to assess billet material's deformability, it would be sufficient to generate the mathematical model of deformations' trajectory within "stress state indicator – accumulated plastic deformation" coordinates.

On the basis of (24), with respect to the initial deformation moment of, we obtain the following condition:

$$h(e_j = 0) = \frac{\sqrt{3} \cdot (q - 1)}{\sqrt{q^2 - 3 \cdot (q - 1)}}, \quad q \hat{\in} [0, 1] \quad (27)$$



being the generalization of the previous condition in case of generation of a more rigid, as compared to uniaxial compression, stress state at the first stage of deformation – prior to the initially cylindrical sample’s acquiring a barrel-type shape.

It is believed that depending on the amount of displacement of conical roll’s top relative to the billet axis in the direction of the contact spot, the stress state of the free surface at the initial moment of deformation can not be stiffer compared to the shear stress state:

$$h(q = 0, e_j = 0) = 0. \quad (28)$$

Fig. 6 shows the graphs giving an idea of the patterns of changes in the possible values of the stress state with the growth of plastic

Taking into account (9), we get:

$$\bar{e}_i(\varepsilon_\varphi) = \frac{\sqrt{3}}{6} \cdot \int_0^{\varepsilon_\varphi} \sqrt{(2-\theta)^2 \cdot \left(1 + \frac{3 \cdot m^2}{\varepsilon_\varphi^2 + m^2}\right)^2 - 4 \cdot (2-\theta) \cdot \left(1 + \frac{3 \cdot m^2}{\varepsilon_\varphi^2 + m^2}\right) + 16 \cdot d\varepsilon_\varphi} \cdot d\varepsilon_\varphi \quad (30)$$

In fact, we obtained an analytical representation of the deformation trajectory in a parametric form with ε_φ parameter. Indeed, based on (24) and (30), we can write as follows:

$$\left\{ \begin{aligned} \eta(\varepsilon_\varphi) &= \frac{\sqrt{3} \cdot \left((\theta - 2) \cdot \left(1 + \frac{3 \cdot m^2}{\varepsilon_\varphi^2 + m^2} \right) + 4 \right)}{\sqrt{12 + \left((\theta - 2) \cdot \left(1 + \frac{3 \cdot m^2}{\varepsilon_\varphi^2 + m^2} \right) + 2 \right)^2}}, \{ \varepsilon_\varphi, m \} \in [0, \infty), \theta \in [0, 1] \\ \bar{e}_i(\varepsilon_\varphi) &= \frac{\sqrt{3}}{6} \cdot \int_0^{\varepsilon_\varphi} \sqrt{(2-\theta)^2 \cdot \left(1 + \frac{3 \cdot m^2}{\varepsilon_\varphi^2 + m^2}\right)^2 - 4 \cdot (2-\theta) \cdot \left(1 + \frac{3 \cdot m^2}{\varepsilon_\varphi^2 + m^2}\right) + 16 \cdot d\varepsilon_\varphi} \end{aligned} \right. \quad (31)$$

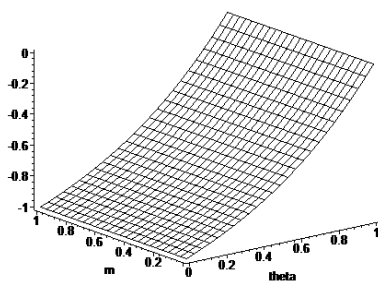

a)

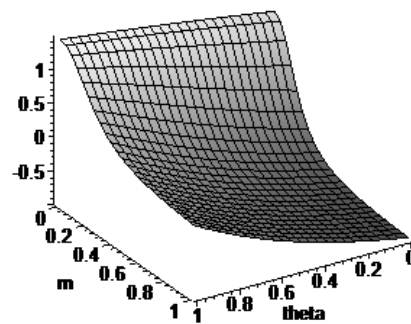

b)

deformation depending on the parameters of the model generated.

According to presentation (24), each particular deformation trajectory is determined by fixed values of q and m parameters. For the analytical presentation of the deformation trajectory, we still need to obtain the description of accumulated plastic deformation.

As the basis, we will take the following relationship for accumulated deformation [7, 8]:

$$\bar{e}_i(\varepsilon_\varphi) = \frac{2\sqrt{3}}{3} \cdot \int_0^{\varepsilon_\varphi} \sqrt{\left(\frac{d\varepsilon_z}{d\varepsilon_\varphi}\right)^2 + \frac{d\varepsilon_z}{d\varepsilon_\varphi} + 1} \cdot d\varepsilon_\varphi \quad (29)$$

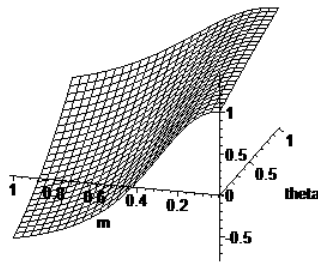

c)

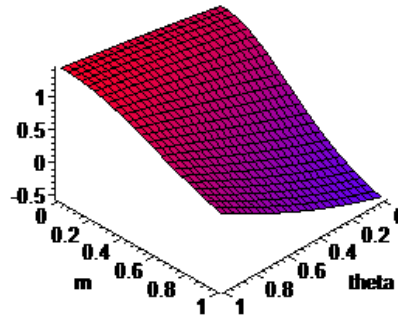

d)

Fig. 6. Stress state indicator η depending on parameters q та m at different stages of plastic deformation: calculation according to (24); $e_j = a$) 0, b) 0.25, c) 0.6, d) 0.85.

The authors of [7, 8] use a parametric representation of the deformation trajectory with another t parameter:

$$\varepsilon_\varphi = m \cdot tg(t), t \in \left[0, \frac{\pi}{2}\right]. \quad (32)$$

After some transformations, we obtain:

$$\left\{ \begin{array}{l} \eta(t) = \frac{\frac{3}{2} \cdot (4 - (2 - \theta) \cdot (1 + 3\cos^2(t)))}{\sqrt{9 + \frac{3}{4} \cdot (2 - (2 - \theta) \cdot (1 + 3\cos^2(t)))^2}}, \\ \bar{e}_i(t) = \frac{\sqrt{3}}{6} \cdot m \cdot \int_0^t \frac{\sqrt{(2 - (2 - \theta) \cdot (1 + 3\cos^2(t)))^2 + 12}}{\cos^2(t)} \cdot dt, \end{array} \right. \quad m \in [0, \infty), \theta \in [0, 1], t \in \left[0, \frac{\pi}{2}\right]. \quad (34)$$

At the initial moment of deformation with $t = 0$, the following emerges from this ratio:

$$\left\{ \begin{array}{l} \eta(0) = \frac{2 \cdot (\theta - 1)}{\sqrt{1 + \frac{1}{3} \cdot (2 \cdot \theta - 1)^2}}, \\ \bar{e}_i(0) = 0, \end{array} \right. \quad \theta \in [0, 1] \quad (35)$$

that is, the deformation trajectory can originate at the points of the abscissa axis located to the right of point $\eta = -1$.

In a separate case, with $\theta = 0$, relation (34) turns into the following expression:

Let's transform the parametric representation taking into account the last substitution. When searching for the definite integral, one should take into account that:

$$d\varepsilon_\varphi = \frac{m}{\cos^2(t)} \cdot dt. \quad (33)$$

$$\left\{ \begin{array}{l} \eta(t) = \frac{1 - 3\cos^2(t)}{\sqrt{1 + 3\cos^4(t)}}, \\ \bar{e}_i(t) = m \cdot \int_0^t \sqrt{3 + \frac{1}{\cos^4(t)}} \cdot dt, \end{array} \right. \quad m \in [0, \infty), t \in \left[0, \frac{\pi}{2}\right], \quad (36)$$

which was obtained by the authors of [7, 8].

Note that the last relation has only one material constant m , while generalized relation (34) has two material constants – q and m . Another advantage of the last obtained relation is the absence of a material constant in the analytical expression for a stressed state of the deformation trajectory's parametric representation. This entails an additional convenience of analyzing these ratios and selecting the material constant value on the basis of experimental data. In generalized relations (34), material constant m is also absent in the analytical expression for the stress state indicator, but there remains material constant q .

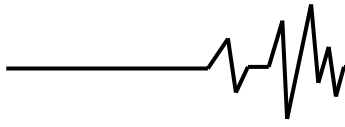

These shortcomings represent a natural price for the possibility of building a more adequate model of change in the SSS of material macroparticle on the billet's free surface in the course of the during roll stamping, provided that conical roll's top is displaced from the billet axis in the direction of the contact spot.

Fig. 7 shows the deformation trajectories constructed by us for different values of material constants q and m .

The advantages of representing the deformation trajectory in the form of parametric equations consist in the convenience of analyzing

these trajectories. Yes, with the fixed value of constant q we can determine the value of parameter t corresponding to the intersection point of the ordinate axis deformation trajectory of the. Based on the first equation of system (34), let's write as follows:

$$\eta(t) = 4 - (2 - \theta) \cdot (1 + 3\cos^2(t)) = 0, t \in \left[0, \frac{\pi}{2}\right]. \quad (37)$$

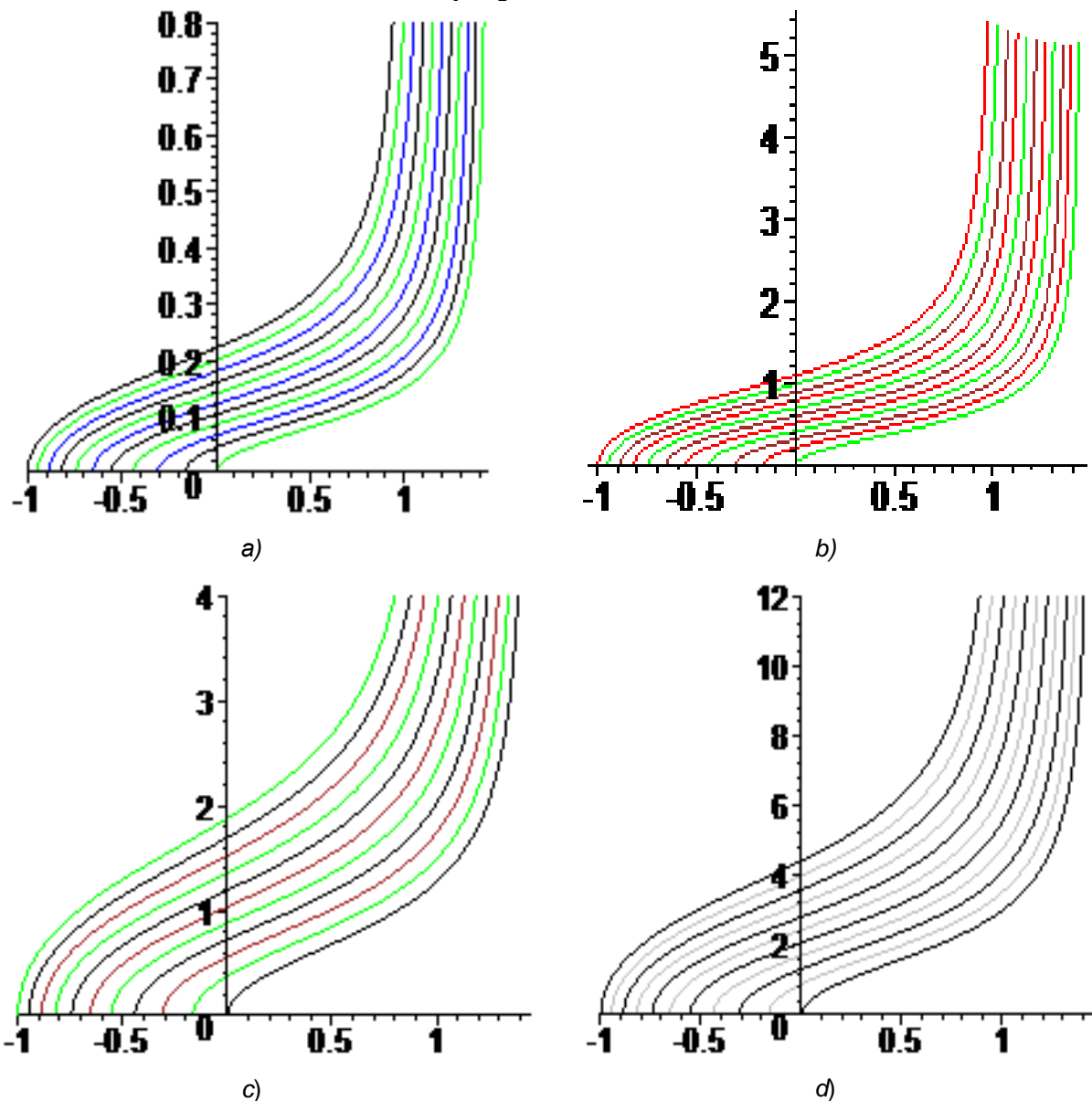
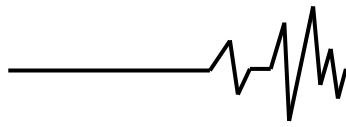

Fig. 7. Deformation trajectories $\bar{e}_i = \bar{e}_i(h)$ – calculation according to (34):

$q \hat{I} [0; 1]$

$m =$ a) 0.1, б) 0.5, в) 0.85, г) 2.0.

Whence it follows:



$$t = \arccos\left(\sqrt{\frac{2+\theta}{3\cdot(2-\theta)}}\right) \quad (38)$$

For example, with $\theta = 0$, $t \approx 0.9553166180$. Based on the second equation of system (36), we determine as follows:

$$\frac{\bar{\epsilon}_i(t = 0.9553166180)}{m} = \int_0^{0.9553166180} \sqrt{3 + \frac{1}{\cos^4(t)}} \cdot dt \approx 2.206, \quad (39)$$

From the last equality, it is easy to determine the ordinate (the amount of accumulated deformation) of the point of intersection between the deformation trajectory and the ordinate axis, and in particular:

$$\begin{aligned} \bar{\epsilon}_i(\eta = 0, m = 0.2) &\approx 0.44; \bar{\epsilon}_i(\eta = 0, m = 0.7) \approx 1.54; \\ \bar{\epsilon}_i(\eta = 0, m = 1.2) &\approx 2.65; \bar{\epsilon}_i(\eta = 0, m = 1.8) \approx 3.97 \end{aligned} \quad (40)$$

Conclusions. The problems of analyzing the stress-strain state of the material particles in the peripheral zone of the outer flange of the pipe billet during planting by the SSS method are considered. An analytical representation of the deformation trajectory is applied based on the construction of a differential equation between the components of plastic deformation increments, followed by the solution of this equation and the identification of its parameters based on experimental data. An analytical representation of the deformation trajectory in a parametric form was obtained, the advantage of which is the convenience of analyzing these trajectories. The advantage of the developed model of the trajectory of the deformation of the material particles of the peripheral zone of the flange when planting by the SSS method in the coordinates "stress state indicator - accumulated plastic deformation until failure" is the absence of a material constant in the analytical expression for the stress state, and the consequence is additional convenience of analyzing ratios and selecting the value of the material constant based on experimental data.

According to the given methodology, the dependences of the stress state indicator on the influence parameters at different stages of plastic deformation and the trajectory of the deformation of the material particles of the peripheral zone of the flange during planting by the SSS method are constructed.

References

1. Matviychuk V. A. Development of energy- and resource-saving technologies of procurement production. *Technology, energy, transport of agricultural industry*. 2022. No. 4 (119). P. 110-119.

2. V. A. Matviychuk., I. S. Aliyev. "Improving the processes of local rotational pressure processing based on the analysis of the deformability of metals". Kramatorsk: DGMA. *Monograph*. 2009.

3. Viktor Matvijchuk, Andrii Shtuts, Mykola Kolisnyk, Ihor Kupchuk, Iryna Derevenko. Investigation of the tubular and cylindrical billets stamping by rolling process with the use of computer simulation. *Periodica Polytechnica, Mechanical Engineering*. 2022. №1 (66), P. 51–58.

4. Matviychuk V.A., Mikhalevich V.M., Kolisnyk M.A. Evaluation of the deformability of the material of the blanks during direct and reverse extrusion by the rolling stamping method. *Vibrations in engineering and technology*. 2022. No. 1(104). P. 81-91.

5. Mikhalevich V. M. Tensor models of damage accumulation. . Vinnytsia: «UNIVERSUM – Vinnytsia». 1998. P. 195.

6. V. A. Matviychuk, Development of local deformation processes: V. A. Matviychuk, V. M. Mikhalevich. Monograph: Theory and practice of processing materials by pressure. Zaporozhye, ed. JSC "Motor Sich", 2016. P. 339-363.

7. Mikhalevich V. M. Modeling of plastic deformation in a cylindrical specimen under edge compression / V. M. Mikhalevich, A. A. Lebedev and Yu. V. Dobranyuk // *Strength of Materials*. - Volume 43, Number 6 (2011), P. 591-603.

8. V. M. Mikhalevich, Yu. V. Dobranyuk. Modeling of the stress-strain and limit states of the surface of cylindrical samples under end compression: monograph. Vinnytsia: VNTU, 2013. – 180 p. ISBN 978-966-641-532-8.

9. V. M. Mikhalevich, Yu. V. Dobranyuk, O. V. Kraevskyi. Comparative study of models of limit plastic deformations. *Herald of mechanical engineering and transport*. 2018. – No. 2(8). P. 56-64.

10. Lebedev A. A., Mikhalevich V. M. On the Choice of Stress Invariants in Solving Problems of Mechanics//*Strength of Materials N 35 (3)* , Plenum Publishing Corporation (USA), May - June, 2003, 217-224.

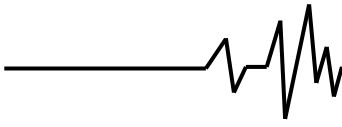

11. Kraevsky V. O., Matviychuk V. A., Mikhalevich V. M. Influence of technological parameters on the kinematics of cold end rolling. *Improvement of pressure processing processes and equipment in mechanical engineering and metallurgy. Kramatorsk. Slavyansk.* 2003. pp. 286–291.

12. Gundebommu S.L., Matvijchuk V., Rubanenko O., Branitskiy Yu. Justification and development of methods building curves boundary deformation of metals. *Materials Today: Proceedings*, 2021, 38, P. 3337–3344.

АНАЛІЗ СТАНУ НАПРУГИ ТА ДЕФОРМАЦІЇ МАТЕРІАЛУ ЗАГОТОВКИ ПРИ ПОСАДЦІ РЕСУРСОЗБЕРІГАЮЧИМ МЕТОДОМ ШТАМПУВАННЯ ПРОКАТОМ

Процеси посадки заготовок методом прокатного штампування дозволяють ефективно виробляти широкий асортимент високоякісної продукції, але можливість руйнування матеріалу при деформації перешкоджає розширенню їх технологічних можливостей. Подальший розвиток процесів можливий шляхом розробки нових технологічних схем на основі аналізу кінематики деформації та призначення сприятливих технологічних параметрів з урахуванням їх впливу на напружено-деформований стан та деформованість матеріалу заготовок. З метою широкого використання методу оцінки деформованості заготовок необхідна надійна техніка, яка передбачає наявність математичної моделі траєкторії деформації частинок матеріалу в координатах «індикатор напруженого стану -

накопичена пластична деформація перед відмовою». У роботі використано підхід до знаходження аналітичного представлення траєкторії деформації на основі побудови диференціального рівняння між компонентами приростів пластичної деформації з подальшим розв'язанням цього рівняння та ідентифікацією його параметрів на основі експериментальних даних. За результатами досліджень, траєкторії деформації частинок матеріалу периферійної поверхні фланця при посадці методом прокатного штампування схематично будувалися в координатах «інтенсивність деформацій - індикатор напруженого стану». На основі побудованої моделі накопичення пошкоджень можна моделювати шляхом зміни значень параметрів моделі для різних матеріалів і шляхів деформації. Отримано аналітичне представлення траєкторії деформації в параметричному вигляді. Перевагами представлення траєкторії деформації у вигляді параметричних рівнянь є зручність аналізу цих траєкторій. Перевага моделі траєкторії деформації частинок матеріалу в координатах «індикатор напруженого стану - пластичний штамп, накопичений до відмови» - це відсутність матеріальної константи в аналітичному виразі для напруженого стану, а наслідком є додаткова зручність аналізу співвідношень і вибору значення матеріальної константи на основі експериментальних даних.

Ключові слова: кочувальне штампування, фланцева посадка, напружено-деформаційний стан, математична модель траєкторії деформації.

ВІДОМОСТІ ПРО АВТОРІВ

Матвійчук Віктор Андрійович – доктор технічних наук, професор, завідувач кафедри «Електроенергетики, електротехніки та електромеханіки» Вінницького національного аграрного університету (вул. Сонячна, 3, м. Вінниця, 21008, Україна, e-mail: vamatv50@gmail.com).

Михалевич Володимир Маркусович – доктор технічних наук, професор, кафедра електроенергетики, електротехніки та електромеханіки» Вінницького національного аграрного університету (вул. Сонячна, 3, м. Вінниця, 21008, Україна, email: mykhalevych@vntu.edu.ua).

Штуць Андрій Анатолійович – асистент кафедри «Електроенергетики, електротехніки та електромеханіки» Вінницького національного аграрного університету (вул. Сонячна, 3, м. Вінниця, 21008, Україна, email: shtuts1989@gmail.com).

Matviychuk Viktor – Doctor of Technical Sciences, Full Professor, Head of the Department of Electric Power Engineering, Electrical Engineering and Electromechanics, Vinnitsa National Agrarian University (3 Solnechna St., Vinnitsa, 21008, Ukraine, email: vamatv50@gmail.com)

Mykhalevych Volodymyr – Doctor of Technical Sciences, Full Professor, Department of Electric Power Engineering, Electrical Engineering and Electromechanics, Vinnitsa National Agrarian University (3 Solnechna St., Vinnitsa, 21008, e-mail: mykhalevych@vntu.edu.ua)

Shtuts Andrii – Assistant Professor, Department of Electric Power Engineering, Electrical Engineering and Electromechanics, Vinnitsa National Agrarian University (3, Solnechna str., Vinnitsa, 21008, Ukraine, email: shtuts1989@gmail.com).