



TRADITIONAL AND
INNOVATIVE
APPROACHES TO
SCIENTIFIC RESEARCH:
THEORY, METHODOLOGY,
PRACTICE

TRADITIONAL AND INNOVATIVE
APPROACHES TO SCIENTIFIC RESEARCH:
THEORY, METHODOLOGY, PRACTICE

RIGA,
LATVIA
2022

RIGA, LATVIA | 2022

IZDEVNIECĪBA
BALTIJA
PUBLISHING





**TRADITIONAL AND INNOVATIVE
APPROACHES TO SCIENTIFIC RESEARCH:
THEORY, METHODOLOGY, PRACTICE**

Scientific monograph

Rīga, Latvia

2022

UDK 0(082)
Tr054

Title: Traditional and innovative approaches to scientific research: theory, methodology, practice

Subtitle: Scientific monograph

Scientific editor and project director: Anita Jankovska

Authors: Oleksandr Voznyak, Andrii Shtuts, Andrii Zahorulko, Aleksey Zagorulko, Oksana Lytvyniak, Yaroslav Lytvyniak, Viktor Matviychuk, Andrii Shtuts, Oleksandr Obodovych, Olesya Stepanova, Olexandr Sudarykov, Alyona Shved, Lilia Batyuk, Nataliya Kizilova, Anatoly Zelensky, Olena Honcharova, Mykola Kovalov, Yuri Bandazheuski, Nataliia Dubovaya, Viktor Sarancha, Viktoriia Shabunina, Svitlana Fiialka, Ivan Prylepa, Larysa Sushchenko, Kateryna Chekaniuk, Mariana Markova, Oksana Tur, Viktoriia Shabunina, Sergiy Selivanov, Maksym Romanov, Yuliia Aleskerova, Kateryna Burko, Tetiana Ganushchak, Olena Zhuk, Oksana Dovhun, Nataliia Mashchak, Lidia Fedoryshyna

Publisher: Publishing House "Baltija Publishing", Riga, Latvia

Available from: <http://www.baltijapublishing.lv/omp/index.php/bp/catalog/book/257>

Year of issue: 2022

All rights reserved. No part of this book may be reprinted or reproduced or utilized in any form or by any electronic, mechanical, or other means, now known or hereafter invented, including photocopying and recording, or in any information storage or retrieval system, without permission in writing from the publisher and author.

Traditional and innovative approaches to scientific research: theory, methodology, practice: Scientific monograph. Riga, Latvia: Baltija Publishing, 2022. 668 p.

ISBN: 978-9934-26-241-8

DOI: <https://doi.org/10.30525/978-9934-26-241-8>

The scientific monograph presents traditional and innovative approaches to modern scientific research. General issues of technical and physical and mathematical sciences, economic sciences, agrarian sciences, law and public administration, social communications, historical sciences, philological and pedagogical sciences, etc. are considered. The publication is intended for scientists, teachers, graduate students and students, as well as a wide audience.

© Izdevniecība "Baltija Publishing", 2022
© Authors of the articles, 2022

Table of Contents

CHAPTER «ENGINEERING SCIENCES»

Oleksandr Voznyak, Andrii Shtuts

INVESTIGATION OF THE PROCESS OF MEASUREMENT
CONTROL OF THE CONCENTRATION OF CARBON DIOXIDE 1

Andrii Zahorulko, Aleksey Zagorulko

INNOVATIVE METHOD OF MANUFACTURING FUNCTIONAL
ORGANIC SEMI-FINISHED PRODUCTS OF A HIGH STAGE
OF READINESS ON THE BASIS OF LOW-TEMPERATURE HEAT
AND MASS EXCHANGE EQUIPMENT. 28

Oksana Lytvyniak, Yaroslav Lytvyniak

A SIMULATION OF COMPOSITE REINFORCED
CONCRETE – FOAM CONCRETE FLOOR SLAB. 68

Viktor Matviychuk, Andrii Shtuts

CONSTRUCTION OF CURVE BOUNDARY
DEFORMATIONS OF METALS. 90

Oleksandr Obodovych, Olesya Stepanova

NUMERICAL SIMULATION OF THE PROCESSES
OF HYDRODYNAMICS AND HEAT TRANSFER PROCESSES
IN ROTOR-PULSATION APPARATUS. 114

Olexandr Sudarykov

ANALYTICAL REVIEW OF INTERNATIONAL DOCUMENTS
RATIFIED IN UKRAINE AND NATIONAL REQUIREMENTS FOR
THE OPERATION OF EQUIPMENT THAT BURNS ORGANIC FUEL 135

Alyona Shved

EXPERT KNOWLEDGE ANALYSIS TECHNOLOGY
WITH FUZZY PREFERENCE RELATION. 152

CHAPTER «PHYSICAL AND MATHEMATICAL SCIENCES»

Lilia Batyuk, Nataliya Kizilova

BIOPHYSICAL BIOMARKERS OF HUMAN ERYTHROCYTES
FOR EFFICIENT DIAGNOSTICS OF STROKE. 170

Anatoly Zelensky

THE METHOD OF INTEGRATING SYSTEMS OF HIGH-ORDER EQUILIBRIUM EQUATIONS OF THE MATHEMATICAL THEORY OF THICK PLATES UNDER INTERMITTENT LOADS (PART 2)	188
---	-----

CHAPTER «AGRICULTURAL SCIENCES»

Olena Honcharova

EFFICIENCY OF COMPLEX TECHNOLOGICAL SOLUTIONS FOR GROWING FISH TO INCREASE RESISTANCE TO THE INFLUENCE OF ABIOTIC AND BIOTIC FACTORS UNDER THE INFLUENCE OF CLIMATE TRANSFORMATIONS.	218
--	-----

Mykola Kovalov

CULTIVATION OF FRAGARIA ANANASSA IN PROTECTED AND OPEN SOIL CONDITIONS.	236
--	-----

CHAPTER «MEDICAL SCIENCES»

Yuri Bandazheuski, Nataliia Dubovaya

HYPERHOMOCYSTEINEMIA AND FOLATE CYCLE GENES IN GIRLS AND BOYS LIVING NEAR THE CHERNOBYL EXCLUSION ZONE.	268
---	-----

CHAPTER «HISTORICAL SCIENCES»

Viktor Sarancha, Viktoriia Shabunina

THE IMPACT OF THE FIRST WORLD WAR ON THE SOCIO-CULTURAL DEVELOPMENT OF THE POLTAVA PROVINCE AND THE PROVINCIAL SOCIETY IDEOLOGY.	283
---	-----

CHAPTER «SOCIAL COMMUNICATIONS»

Svitlana Fiialka

SCIENTIFIC JOURNAL AS SOCIO-COMMUNICATIVE PHENOMENON: FORMATION AND DEVELOPMENT TRENDS.	306
---	-----

CHAPTER «PEDAGOGICAL SCIENCES»

Ivan Prylepa

TECHNOLOGIES FOR THE DEVELOPMENT
OF CROSS-DISCIPLINARY COMPETENCE
OF FUTURE TEACHERS OF PROFESSIONAL EDUCATION. 336

Larysa Sushchenko

METHODOLOGY FOR ORGANIZING
THE RESEARCH ACTIVITIES OF STUDENTS
IN EDUCATIONAL PROCESS: RESULTS OF THE STUDY. 384

Kateryna Chekaniuk

TECHNOLOGIES OF PROFESSIONAL DEVELOPMENT
OF BIOLOGY TEACHERS IN THE EDUCATIONAL ENVIRONMENT
OF GENERAL SECONDARY EDUCATION INSTITUTIONS. 409

CHAPTER «PHILOLOGICAL SCIENCES»

Mariana Markova

THE PHENOMENON OF PETRARCHISM IN THE LIGHT
OF DENNIS DE ROUGEMONT'S THEORETICAL IDEAS. 447

Oksana Tur, Viktoriia Shabunina

LEXICAL AND SEMANTIC ORGANIZATION OF UKRAINIAN
TERMINOLOGY OF LAND MANAGEMENT AND LAND CADASTRE. . . 474

CHAPTER «STATE ADMINISTRATION»

Sergiy Selivanov

FOREIGN EXPERIENCE IN PROFESSIONALIZING HUMAN
RESOURCES CIVIL SERVICE AND OPPORTUNITIES
FOR ITS IMPLEMENTATION IN UKRAINE. 505

CHAPTER «LAW SCIENCES»

Maksym Romanov

TACTICAL PROVISION OF PRE-TRIAL INVESTIGATION
OF ILLEGAL OBSTRUCTION OF THE ORGANIZATION
OR HOLDING OF MEETINGS, RALLIES, MARCHES
AND DEMONSTRATIONS. 527

CHAPTER «ECONOMIC SCIENCES»

Yuliia Aleskerova

MANAGEMENT OF THE CREDIT PROCESS IN UKRAINE. 562

Kateryna Burko

SCOPE OF APPLICATION OF MANAGEMENT
ACCOUNTING TOOLS FOR THE NEEDS
OF MANAGEMENT OF THE BEEKEEPING INDUSTRY. 581

Tetiana Ganushchak, Olena Zhuk

FINANCIAL CONTROLLING AS A COMPONENT
OF CORPORATE CRISIS MANAGEMENT
AND INTEGRATION OF ITS TOOLS INTO ERP SYSTEMS. 599

Oksana Dovhun, Nataliia Mashchak

STATE AND PROSPECTS OF UKRAINIAN CLOTHING
MANUFACTURERS AND BUSINESS IN GENERAL
IN THE WAR CONDITIONS. 620

Lidiia Fedoryshyna

INCREASING THE EFFICIENCY OF THE FINANCIAL
PROFITABILITY OF THE INSURANCE COMPANY
(ON THE EXAMPLE OF ARKS INSURANCE COMPANY). 641

CONSTRUCTION OF CURVE BOUNDARY DEFORMATIONS OF METALS

Viktor Matviychuk¹
Andrii Shtuts²

DOI: <https://doi.org/10.30525/978-9934-26-241-8-4>

Abstract. The work deals with the problems of studying the plasticity of metals, which are associated with the lack of methods of constructing a "single" curve of limit deformations due to the formation of a neck during stretching of samples and the formation of a barrel during deposition, and at the same time, the increase in plasticity due to the implementation of complex deformation. The purpose of this work is to develop a technique for constructing curves of limit deformations of metals with simple deformation and a constant value of the stress state indicator and to use them for objective assessment of the deformability of the material of the workpieces in the technological processes of plastic molding. The main method of research is an experiment with the creation of controlled and controlled conditions for the deformation of samples. In addition, an experimental and computational method was considered, which involves the construction of deformation paths during the deposition of cylindrical samples and the correction of the limit deformation using the deformability criterion. We found that during stretching, in the case of neck formation, the increase in deformation depends linearly on the ratio of the radius of curvature of the neck to its diameter. An equation is presented, which can be used to take into account the effect of the neck on the increase in limit deformations using the experimental and computational method. A method of rolling a cylindrical sample into a wedge with rolls, the radii of which increase during the rolling process, has been developed. The method provides the possibility of testing cylindrical samples under constant stress and allows obtaining values of plasticity under conditions of uniaxial tension. Curves of limit deformations, with the precision necessary for practice, are proposed to be

¹ Doctor of Technical Sciences, Associate Professor,
Vinnitsa National Agrarian University, Ukraine

² Assistant, Vinnytsia National Agrarian University, Ukraine

built based on the results of testing samples for torsion and settling using an approximate dependence. Curves of limit deformations of a number of steels were constructed according to the given method. The resulting curves of limit deformations are constructed excluding the influence of the deformation history on them and can be used for objective evaluation of the deformability of the workpiece material in technological processes.

1. Introduction

Production efficiency is an urgent requirement of modern mechanical engineering, in which the improvement of workpiece manufacturing processes is carried out at the stage of primary molding of parts. The maximum saving of material, labor and financial resources can occur due to minimal discrepancies between the geometric parameters of the workpieces and the dimensions of the finished parts, provided that the necessary physical and mechanical properties are ensured.

Modern metalworking involves the need to ensure high production efficiency, which determines the wide use of pressure metal processing (PMP) processes as procurement operations. A special place among them is occupied by cold deformation processes, however, their implementation is limited mainly by the danger of destruction of metals.

In the nomenclature of stamped workpieces, a significant amount is occupied by details of complex types of profiles. In the production of parts from ring workpieces, the rolling stamping method has recently become widely used [1]. Its characteristic difference is that the deformation zone has a local character, and the formation of the workpiece occurs as a result of its repeated rolling with cylindrical or conical rolls. This improves the flow conditions of the workpiece material in contact with the tool and makes it possible to obtain developed thin-walled elements. At the same time, the required profile of the products can be obtained by applying justified technological schemes, as well as by purposeful mutual arrangement of deformable rolls and the workpiece [2]. Rolling is used as a preparatory operation before voluminous stamping of long parts in order to evenly redistribute the metal of the initial workpiece, eliminate excessive unevenness of deformation, achieve high degrees of deformation, manufacture high-quality products without defects with a high metal utilization ratio. The rolling process is also characterized by local non-

stationary deformation, which allows obtaining complex profile workpieces with significant degrees of deformation. For a number of ductile metals, it is advisable to carry out this process under conditions of cold deformation.

Assessment of the deformability of the workpiece material, i.e., the ability to change shape by PMP methods without destruction, can be carried out according to known criteria [3; 4], however, for this, it is necessary to have reliable curves of boundary deformations of materials constructed for various indicators of the stress state. Studies have shown that in most PMP processes a stress state is realized, which is between linear compression and tension, therefore this area is of the greatest interest from the point of view of assessing the deformability of the material of the workpieces. In addition, the region with a "softer" stress state compared to single axial compression is characterized by favorable conditions of deformability with a significantly lower risk of failure. And the areas with a more "stiff", compared to single axial tension, stress state are characteristic mainly for sheet stamping and need more attention precisely from the standpoint of preventing local thinning (neck), rather than the classic formation of cracks. Thus, when assessing the deformability of metals in most PMP processes, it is enough to test them for compression, torsion, and tension in order to construct the boundary deformation curves. However, a number of difficulties arise due to the fact that the curves of boundary deformations must be constructed at constant values of the stress state indicator. But, during the deposition of cylindrical samples, the linear stress state is lost with the appearance of a barrel due to friction at the ends, and during stretching – due to the loss of resistance to deformation and the formation of a neck. The results obtained in this way include the deformation history, and therefore are not entirely suitable for constructing the boundary deformation curves.

Recently, a significant number of works have been devoted to the study of the development of processes of cold ductile deformation of metals based on the assessment of their deformability. In mechanical engineering, a significant number of complex profile parts are produced by cold stamping methods. At the same time, the wide application of these methods is limited by the insufficient development of the calculation apparatus for assessing the deformability of the material of the workpieces, the value of the plasticity resource used to prevent their destruction. Therefore, determining the boundary curves of metals and alloys is a current task.

2. Analysis of plasticity of metals, curve of boundary plasticity and ways of their construction

In the processes of cold deformation, along with the strengthening of the metal and the formation of a favorable microstructure, there is an accumulation of damage in it, which leads to a decrease in the density of the material and a decrease in residual plasticity indicators. Therefore, when a certain level of deformation is exceeded, there is a deterioration of the service characteristics of the products, up to the destruction of the workpieces in the process of ductile processing or the products during operation.

Therefore, it is impossible to ensure the necessary quality of products when processed by PMP methods without assessing the deformability of metals, that's why their ability to deform without breaking, with minimal depletion of the plasticity resource.

Plasticity refers to the ability of metals to change shape irreversibly without breaking. As a rule, this ability is limited, since the deformation of metals is accompanied by an increase in the density of linear and point defects, the appearance and increase of micropores and microcracks, which leads to loosening of the metal, the formation of a main crack and destruction, Figure 1.

The accumulation of damage in the metal is accompanied by a decrease in its density and a change in a number of electrical characteristics [5]. In Figure 2 shows the dependence of the change in the density of alloys obtained by us when they exhaust the plasticity resource in cold deformation processes.

As can be seen from Figure 2, at the initial stages of deformation of most metals, a slight intensity of density reduction is observed. EI961 alloy during deposition to values $\psi_u \leq 0,4$ it even becomes somewhat denser, and only later does the density decrease. Titanium alloys VT8 and VT9 are deformed at a relatively small intensity of

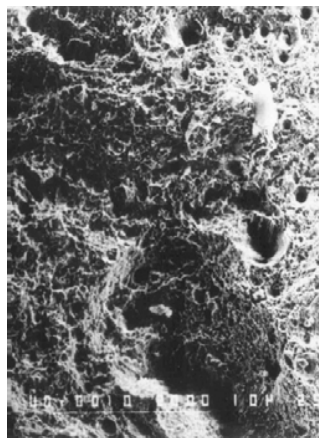
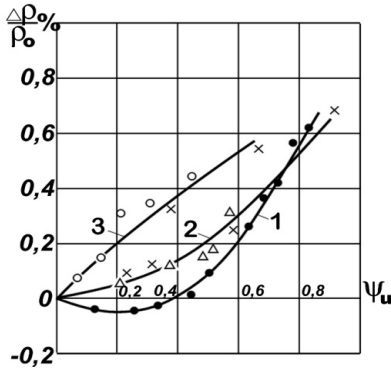

Figure 1. Appearance of damage on the surface of the plastic failure zone
1 – EI961 alloy; 2 – VT9 alloy; 3 – EP718 alloy



**Figure 2. Dependence of plastic loosening of metals $\Delta\rho/\rho_0$ on the value of the plasticity resource used: ψ_u : •, o – compression; Δ – torsion; x – stretch
1 – EI961 alloy; 2 – VT9 alloy;
3 – EP718 alloy**

density reduction in the initial stages. In the EP718 alloy, the dependence of the decrease in density on the value of the used plasticity resource turned out to be close to linear. The amount of plastic loosening at 50% use of the plasticity resource for different materials and types of tests is within $\Delta\rho/\rho_0 = 0.1 - 0.4\%$.

With the increase in the damageability of metals, the relative value of their loosening is leveled off, so that at the values of the $\psi_u = 0.8$ decrease in density for the studied alloys was $\Delta\rho/\rho \approx 0.6\%$. The conducted experiments showed that the subsequent heat treatment completely restores the initial density and plasticity of the material only to the values of the used ductile resource $\psi_u = 0.4$.

A main crack, the appearance of which determines the exhaustion of the plasticity of the metal, is understood as such a defect that leads to an irreparable defect in products. In different technological processes, the dimensions of the main crack can be different. The detection of main cracks in the case of cold deformation processes is facilitated by the fact that in the absence of a noticeable gradient of metal damage, the catastrophic development of a main crack occurs without a significant increase in the degree of plasticity.

Ductile deformation is accompanied by an increase in residual deformations. The deformed state at a point can be described by a symmetric tensor of the second rank $\dot{\epsilon}_{ij}$ ($i, j = 1, 2, 3$) – the strain-rate tensor. The components of the strain rate tensor are related to the velocity field U_i ($i = 1, 2, 3$) by the Cauchy relation:

$$\dot{\epsilon}_{ij} = \frac{1}{2} \left(\frac{\partial U_i}{\partial x_j} + \frac{\partial U_j}{\partial x_i} \right), \quad (1)$$

where x_i ($i = 1, 2, 3$) are the Euler coordinates.

As a measure of the deformation rates at a point, one of the variants of the strain rate tensor is accepted – the intensity of the deformation rates $\dot{\varepsilon}_u$, which is a scalar positive value.

The measure of deformation at a material point is the accumulated deformation or degree of deformation:

$$\varepsilon_u = \int_0^{t_k} \dot{\varepsilon}_u dt, \quad (2)$$

Where t_k is the end time of the deformation process.

As a measure of plasticity, the plastic deformation accumulated until the moment of failure is taken [5]:

$$\varepsilon_* = \int_0^{t_p} \dot{\varepsilon}_u d\tau \quad \varepsilon_* = 0 \text{tr} \varepsilon u d\tau, \quad (3)$$

where t_p is the time of deformation to failure.

In the case of simple deformation, when the sign of the main deformations and the constancy of the positions of the main axes relative to the material fibers are preserved, the accumulated deformation (degree of deformation) is equal to the intensity of the logarithmic deformations [3]:

$$\varepsilon_u = \frac{\sqrt{3}}{2} \sqrt{(\varepsilon_1 - \varepsilon_2)^2 + (\varepsilon_2 - \varepsilon_3)^2 + (\varepsilon_3 - \varepsilon_1)^2}, \quad (4)$$

where $\varepsilon_1, \varepsilon_2, \varepsilon_3$ are the main logarithmic deformations.

The plasticity of the metal depends: on the brand and condition; the type of load that determines the sign of the main deformations and the constancy of the position of the main axes relative to the material fibers; stress state indicator; state of the surface of the deforming sample and scale factor; gradients of the deformed state and plastic loosening of the metal; the intensity of the change in the directions of the sliding planes, etc.

The main factor affecting the plasticity of metals under conditions of cold deformation is the stress state scheme. The dependence of plasticity on the parameters characterizing the stress state scheme is called the boundary deformation curve.

The concept of the dependence of plasticity on the stress state indicator has become the most widespread:

$$\eta = \frac{I_1(T_\sigma)}{3\sqrt{I_2(D_\sigma)}} = \frac{3\sigma}{\sqrt{3}\sigma_u} \quad (5)$$

where $I_1(T_\sigma)$ is the first invariant of the stress tensor;

$I_2(D_\sigma)$ – the second invariant of the stress deviator;

$\sigma = \frac{1}{3}\sigma_{ij}\delta_{ij}$ – average tension;

σ_u – stress intensity.

The indicator does η not take into account the influence of the third invariant of the stress tensor, therefore, the boundary stress curve in " ε_u - η " coordinates is not considered to be the only one for all possible types of stress state.

For an objective assessment of the deformability of metals in various technological processes, it is necessary to have a "single" curve of boundary deformations that describes their plasticity under different stress state schemes. Testing of metals for plasticity in a high-pressure chamber using different methods showed different results corresponding to the same value of the stress state indicator. In particular, V. L. Kolmogorov established that plasticity is higher during stretching than during torsion. A. A. Bogatov showed that the results of the tests are different, while which of the characteristics is greater depends on the grade of metal. V. A. Ogorodnikov established [3] that when twisting in a high-pressure chamber, when conditions are created with equal values of the stress state indicator, plasticity will still be lower than when compressed.

In order to exclude possible discrepancies when assessing the deformability of metals, it is necessary that the conditions of identity of the Nadai-Lode parameter, which characterizes the type of stress deviator, are observed in the studied technological process and experiments on the construction of the curve of limit deformations:

$$\mu_\sigma = 2 \frac{\sigma_2 - \sigma_1}{\sigma_1 - \sigma_3} - 1 = \frac{2\sigma_2 - \sigma_1 - \sigma_3}{\sigma_1 - \sigma_3}. \quad (6)$$

The dependence of plasticity on the stress state scheme can be described by constructing the complete surface of plasticity in " $\varepsilon_u - \eta - \mu_\sigma$ " coordinates. This dependence was proposed in the works of S. I. Gubkin, but its construction is associated with difficulties of an experimental nature.

In the paper [3], V. A. Ogorodnikov proposed to construct a plasticity surface in the coordinates " $\varepsilon_u - \mu - \chi$ ", where χ is an indicator that takes into account the third invariant of the stress tensor:

$$\chi = \frac{\sqrt[3]{I_3(T_\sigma)}}{\sqrt{3I_2(D_\sigma)}} = \frac{\sqrt[3]{\sigma_1\sigma_2\sigma_3}}{\sigma_u}. \quad (7)$$

The plasticity surface constructed in the " $\varepsilon_u - \mu - \chi$ ", coordinates can be defined as the surface of boundaries deformations. The intersection of the surface with a plane perpendicular to the axis $\chi = 0$, leads to obtaining a curve of boundaries deformations in $\varepsilon_* = \varepsilon_*(\eta)$ coordinates. To construct the boundary deformation curves according to this technique, it is necessary to conduct time-consuming tests in a high-pressure chamber. This excludes the possibility of compressive testing of ductile materials, and tensile tests lead to distortion of results due to necking.

In work [6], a method of constructing surfaces $\varepsilon_*(\eta, \mu_\sigma)$ by means of simple tests for tension, compression, pure shear and tests for the deposition of cylindrical samples in shells of different thicknesses was developed.

The lack of universality of the qualitative influence of the Nadaya-Lode index on plasticity in the conditions $\eta = const$ has led to the fact that many researchers explain the noted differences in plasticity with the imperfection of methods of testing samples for tension, torsion and compression. However, these explanations do not have well-founded confirmations.

As for the surfaces of boundaries deformations, the same methods of testing samples for tension, torsion and compression are used in their construction, the imperfections of which explain the differences in plasticity when using curves of boundaries deformations. In work [7] it was also confirmed that the plasticity of metals at constant values of the indicator η really depends significantly on the value μ_σ . However, the authors note that it is possible to assert the existence of a plasticity surface only if there are two different points on such a surface with the same value ε_* , but with different combinations of indicators η and μ_σ . But, this position has not been confirmed by experiments.

Possible inaccuracies in the description of the dependence of plasticity on the stress state scheme, when using boundary deformation curves, are characteristic only for areas of comprehensive compression, where the danger of destruction of metals in technological processes ceases to be their

main limiting factor. In addition, in most deformability criteria, the integral function includes a model of the dependence of the boundary deformation ε_* from the indicator η . Therefore, when describing the dependence of plasticity on the scheme of the stress state, the curves of boundaries deformations in coordinates $\varepsilon_* = \varepsilon_*(\eta)$ were the most widespread. At the same time, the contradictory values of plasticity obtained during different types of tests remain problematic. And the main one of such contradictions should be attributed to the "abnormal" increase in plasticity during the formation of the neck in the case of stretching.

The analysis of the stress state of the materials of the workpieces during processing by SR methods showed that the indicator of the stress state η in the dangerous zone of the workpiece is within $-2 \leq \eta \leq 1$, and the Nadai-Lode parameter $0 \leq \mu_\sigma \leq 1$. The plasticity of materials can be determined by the results of testing cylindrical samples for deposition, torsion, and stretching, as well as by performing the specified types of tests in a high-pressure chamber. However, during such tests, problems often arise, which are related to the difficulty of maintaining a constant specified stress state scheme, uniform across the entire cross-section of the sample, as well as maintaining the conditions $\eta = const$ throughout the sample's test time.

Thus, in order to construct the curves of boundary deformations, need to know the nature of the "abnormal" increase in plasticity during the formation of the neck of the stretched sample, as well as ensure testing under the conditions $\eta = const$. The development of test methods for determining the plasticity of metals in case of complex deformation is also of considerable interest.

Thus, determining the plasticity of metals during simple cold deformation is associated with a number of difficulties. By simple or stationary, we understand the deformation in which, $\beta_{ij}(\varepsilon_u) = const$, $\mu_\sigma = const$, where β_{ij} is the guiding tensor of the increase in deformations [4]. This type of deformation must, preferably, be ensured in the case of carrying out tests when constructing boundary deformation curves.

V. A. Matviychuk in work [8] increased plasticity during stretching in the case of neck formation, as shown in Figure 3, is explained by the appearance of complex deformation. In the future, by complex deformation we will understand the case in which the direction tensor of the deformation rates $\beta_{ij}(\varepsilon_u) \neq const$.

During stretching, the deformation process proceeds steadily, without the formation of a neck, if the deformation force $P = \sigma_i S$ (S is the cross-sectional area of the sample) increases with the increase in the intensity of the deformations:

$$\frac{dP}{d\varepsilon_i} = \frac{d(\sigma_i S)}{d\varepsilon_i} = S \frac{d\sigma_i}{d\varepsilon_i} + \sigma_i \frac{dS}{d\varepsilon_i} > 0, \quad (8)$$

where the terms $S \frac{d\sigma_i}{d\varepsilon_i}$ and $\sigma_i \frac{dS}{d\varepsilon_i}$ reflect, respectively, the deformation hardening of the material and the loss of strength of the sample, which is associated with a decrease in the area S .

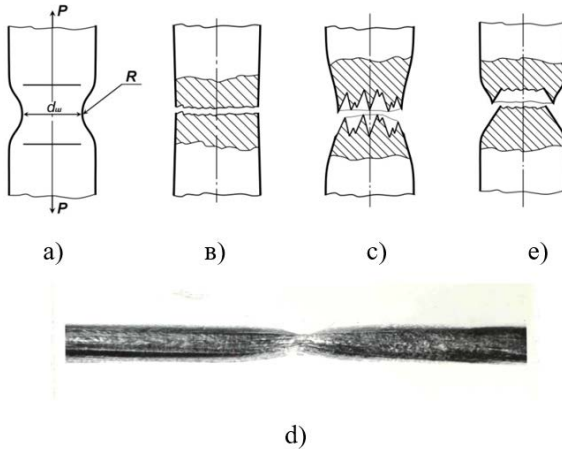

Figure 3. Shape and parameters of the neck (a); view of stretched cylindrical samples in the zone of their destruction by separation (b); cut (c); cut-away (d) and view of the neck of the stretched tantalum sample (e)

At the moment of loss of deformation stability of the cylindrical rod during stretching, when equality is reached, $\varepsilon_u = \varepsilon_p$ the condition is fulfilled $\frac{d\sigma_i}{d\varepsilon_i} = 0$.

In general, the deformation ε_p corresponding to the beginning of neck formation is determined by the material hardening curve and the cross-sectional shape of the sample. In some steels (P18, P6M5), the ultimate

strain before failure is less than the ultimate uniform strain ($\varepsilon_* \leq \varepsilon_p$), that's why their failure is not preceded by the appearance of a neck (Figure 3, b). At the same time, the destruction both in the case of stretching and in the case of torsion occurs by separation, so that the increase in plasticity during stretching is not observed.

In some ductile, high-tensile metals that have a significant amount of relative elongation, a neck of small curvature is formed, and the destruction during stretching and twisting occurs by shearing. At the same time, in the case of stretching, a fibrous fracture is formed (Figure 3, c) and an "abnormal" increase in plasticity is not observed here either. For example, in M0b copper, the ultimate deformation during stretching is 2.5 times less than during torsion.

A developed neck is formed in a number of plastic high-strengthening steels and alloys (EP718, EI961, 12X18H10T), which have a significant amount of relative elongation. The magnitudes of the boundary deformations during torsion ε_* ($\eta = 0$) and stretching ε_* ($\eta = 1$) in these materials have similar values.

In the case of stretching of most steels and alloys, a developed neck with a small radius of curvature is formed, and the destruction occurs by shearing. When cylindrical samples are stretched, a fracture with a conical part of the "cone-cup" type is formed (Figure 3, d). Moreover, for such metals, the value ε_* during stretching is much greater than during torsion, and may be even greater than during deposition.

During stretching, in the case of neck formation, the stress state indicator increases from the periphery to the axis of the sample, reaching on the axis the value $\eta = 3\ln(1+dw/R)+1$ (according to P. Bridgman), where dh is the diameter of the neck; R is the radius of curvature of the neck. Boundaries deformations during stretching ε_* ($\eta \geq 1$) = $2\ln(d_0/d_h)$, where d_0 is the diameter of the original sample.

Thus, with a decrease in the radius of curvature, and, accordingly, the ratio R/d_h , the "abnormal" increase in plasticity increases. Some alloys (VT9, VT25, OT4) form a neck with an elliptical cross-section. At the same time, the increase in the degree of plasticity $\Delta\varepsilon_*$ for each of the axes of the ellipse turned out to be different, but the general nature of its relationship with the parameter R/d_h remained unchanged.

In the process of tensile tests, it was established that in a number of steels and alloys (OT4, VT9, VT25, EP866, EP718), microcracks appear on the surface of the neck long before failure, which stop growing as the neck develops. At the same time, the appearance of similar small cracks during torsion or uniaxial compression is accompanied by further destruction without a noticeable increase in plasticity. The values ε_* ($\eta = 1$) determined at the place of appearance of cracks on the surface of the neck agree well with the values obtained by calculation.

To clarify the effect of inhibiting the development of cracks in the growth zone of the neck, experiments were also conducted on the distribution of ring samples on a deformable cylindrical mandrel that deforms. The use of rings with a two- or three-fold ratio of width to wall thickness made it possible to increase the degree of deformation ε_p , so that rings made of low-plastic alloys OT4, VT9, VT25 were destroyed without significant formation of a neck (Figure 4). At the same time, the experimental values of the boundaries deformations corresponded to the calculated ones, without an "abnormal" increase in plasticity.

As a result of the conducted research, it was established that the appearance of the neck inhibits the development of cracks and increases the plasticity of metals. The reason for this increase is probably related to the change in the nature of the deformed state. The development of the "pore layer", which leads to the spread of cracks, occurs in a narrow area along the slip bands. During deformation, the slip lines are directed to the free surface at an angle of $\pi/4$.

With the appearance of the neck and the curvature of the lateral surface, the direction of the slip lines changes, and the accumulation of plastic loosening occurs in changing directions. Inside the neck, the sliding strip is divided into short segments and moves along a zigzag trajectory. The change in metal particles undergoing the most intensive plastic loosening at the moment leads to an increase in plasticity.

At the same time, the increase in deformation $\Delta\varepsilon^*$ established in [8]

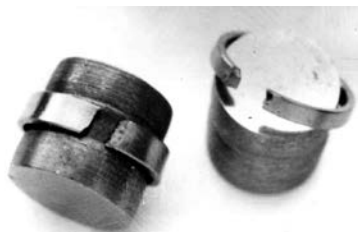

Figure 4. Type of ring samples brought to destruction by distribution on deformable mandrels

depends linearly on the ratio of the radius of curvature of the neck R to its diameter d_h , and when $R/d_h \geq 0,5$ can be described by the equation:

$$\Delta \varepsilon_* = 0,85 - 0,57 R/d_i . \quad (9)$$

In Figure 5 shows a graphical view of the dependence (9) of the increase in the degree of plasticity $\Delta \varepsilon_*$ on the ratio of the radius of curvature of the neck R to its diameter d_h for different materials: O – VT9, Δ – VT25, \times – OT4, \square – EP517, ∇ – EI 961, \circ – EP866, \diamond – EP718.

It should be noted that the appearance of local thinning on workpieces during pressure treatment processes is a sign of a defect, therefore the boundary deformation is quite reasonably taken to be the value ε_p . If the workpieces in the technological processes are destroyed without the formation of a neck, then the values of plasticity obtained from the results of stretching can be used for an objective assessment of deformability.

At the same time, it is necessary to take into account the increase in plasticity, which is due to the formation of a neck and is determined by dependence (7).

Increasing the accuracy of determining the plasticity under stress,

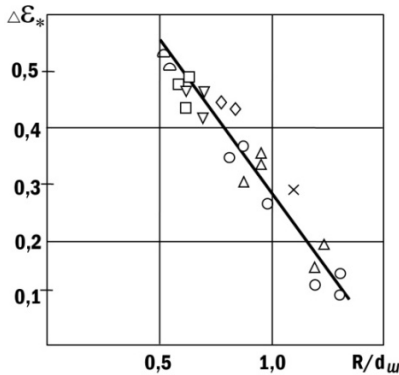

Figure 5. The dependence of the increase in the degree of plasticity $\Delta \varepsilon_*$ on the ratio of the radius of curvature of the neck R to its diameter d_h for different materials

which corresponds to uniaxial tension ε_* ($\eta = +1$), by preventing the loss of resistance to deformation of the sample in the form of a neck and ensuring the constancy of the values of the stress state indicators during the entire test process, can be ensured by rolling the workpieces until failure [9].

According to the noted method, the deformation of the free side surface of the cylindrical sample under conditions of single axial tension occurs when it is rolled with rolls, and the increase in the degree of deformation and bringing the material to destruction is ensured due to the increase in the radii of the rolls during rolling and the deformation of the sample into a wedge.

In Figure 6 shows the rolling of the sample into a wedge with rolls, the radii of which increase. According to the method, the test cylindrical sample 1, with a dividing mesh applied to its side surface, is fixed in the holder 3 and near the holder is pressed by rolls 2 at the smallest radii of their cross-sections. The rotation of the rolls is turned on and the workpiece is rolled into a wedge due to the increase in the radius of the rolls. Plasticity is determined by the amount of deformation at the moment of the appearance of cracks on the free surface of the sample.

If it is necessary to obtain in one test two values of plasticity of the metal at different (but constant during the deformation) indicators of the stress state η , rolling is carried out on a wedge of a curvilinear sample. For this purpose, rolling is carried out with conical rolls, the radii of which increase as the sample is rolled. At the same time, the less deformed inner side surface of the sample will have a smaller value of the indicator η , and the more deformed outer surface of the sample will have a larger value of the indicator η (Figure 7) [9].

Thus, the described method provides the possibility of testing cylindrical samples under a constant stress state during deformation and obtaining two values of plasticity in one test at different constant values of the stress state indicator.

The curves of the boundaries deformations of the materials of the workpieces, which were processed by the stamping and rolling processes, were built based on the results of the study of the samples for deposition and torsion.

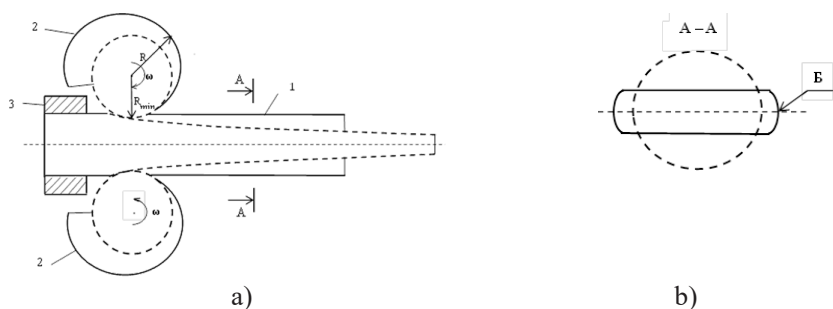

Figure 6. Schematic representation of the wedge rolling process:
a) section of the deformed workpiece;
b) B is the surface of deformation and destruction control

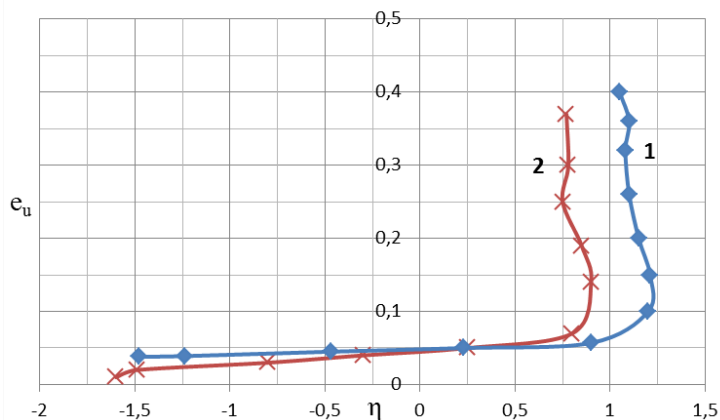

Figure 7. Trajectories of the deformation paths of the outer 1 and inner 2 points of the free side surfaces of the workpiece

When testing cylindrical samples for deposition, the main difficulty is to eliminate friction on the ends of the samples to ensure single axial compression ($\eta = -1, \mu_\sigma = 1$). In Figure 8 shows the scheme of the deposition of solid cylindrical samples with the provision of conditions of linear compression.

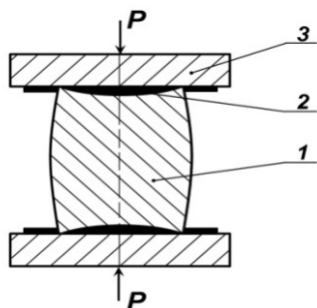

Figure 8. Scheme of deposition of a solid cylindrical sample with conditions of single axial compression: 1 – sample, 2 – foil, 3 – tool

It should be noted that even when using effective lubricant and gaskets made of layers of soft foil, linear compression is difficult to implement.

The use of such methods as step-by-step polishing of the edges of the hole at the ends or pressing them in without foil, followed by step-by-step deposition with foil, makes it possible to withstand a stress state close to linear compression ($\eta = -1$) only up to certain degrees of deformation. At the same time, the intensity of deformation at the time of failure can be determined from the ratio:

$$\varepsilon_* = \ln \frac{h_0}{h_*}, \quad (10)$$

where h_0 and h_* is the height of the initial sample and at the time of failure, respectively.

In Figure 9 shows the view of the original and cross-sections of cylindrical samples deposited to various degrees according to the described method, while maintaining the straightness of the side surfaces.

In the case of distortion of the cylindrical shape of the sample during sedimentation (the appearance of a barrel), the stress state differs from single axial compression. As a result, the condition of constancy of the stress state indicator is violated, what is necessary when constructing the boundary deformation curves.

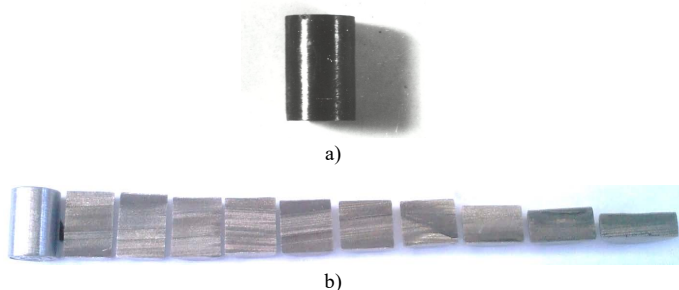

**Figure 9. Samples for deposition testing:
a) initial sample, b) cross-sections of cylindrical samples deposited
under conditions of single axial compression**

In this case, the points of the limit deformation curves can be obtained by the experimental-calculation method.

To construct the paths of deformation of the material particles, on the lateral surface of the samples, near the average height of the section, four impressions are made on the Vickers hardness tester with a diamond pyramid in four symmetrically located points of the equator, Figure 10.

Deposition of the samples is carried out in stages until visible cracks appear on the equator of the side surface. The diagonals of the square a_0, b_0, a_i, b_i are measured in stages in the axial and circumferential directions before and after deposition, respectively. According to the results of the measurements,

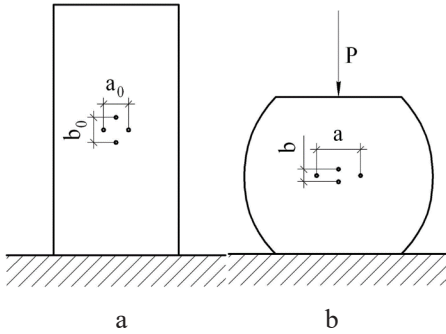

Figure 10. The shape of the samples and the coordinate grid: a) before deposition; b) in the process of deposition

the axis is determined $\varepsilon_z = -\ln \frac{a_0}{a_i}$ and circumferential deformation $\varepsilon_\theta = \ln \frac{b_i}{b_0}$ as well as the value of the strain intensity and the stress state indicator

$$\varepsilon_u = \frac{2}{\sqrt{3}} \sqrt{\varepsilon_z^2 + \varepsilon_z \varepsilon_\theta + \varepsilon_\theta^2}, \quad (11)$$

$$\eta = \sqrt{3} \frac{\varepsilon_z + \varepsilon_\theta}{\sqrt{\varepsilon_z^2 + \varepsilon_z \varepsilon_\theta + \varepsilon_\theta^2}}. \quad (12)$$

Using the path of deformation of the material particles, obtained before the moment of destruction of the sample, and subtracting the deformation increment calculated using the deformability criterion [3], determined by the deformation history, the point on the limit deformation curve is determined. That is, they solve the problem that is the inverse of the assessment of the deformability of the material.

In work [7], the relationship between the components of deformations and their increments is presented in the form:

$$F \left(\frac{d\varepsilon_z}{d\varepsilon_\varphi}, \varepsilon_\varphi, \varepsilon_z \right) = 0 \quad (13)$$

Approximations in the form of a differential equation in the form:

$$\frac{d\varepsilon_z}{d\varepsilon_\varphi} = -\frac{1}{2} - \frac{3}{2} * \frac{m^2}{\varepsilon_\varphi^2 + m^2}, m > 0 \quad (14)$$

Approximations in the form of a solution of the corresponding differential equation:

$$\varepsilon_z = -\frac{1}{2} * \varepsilon_\varphi - \frac{3}{2} * m * \text{arctg} \left(\frac{\varepsilon_\varphi}{m} \right) \quad (15)$$

The analytical representation of the trajectory of deformations in coordinates $\varepsilon_u - \eta$ has the form:

$$\varepsilon_u(t.m) = m \cdot \int_0^t \sqrt{3 + \frac{1}{\cos^4(x)}} \cdot dx, t \in \left[0, \frac{\pi}{2} \right] \quad (16)$$

for accumulated ducline deformation:

$$\eta(t) = \frac{1 - 3\cos^2(t)}{\sqrt{1 + 3\cos^4(t)}}, t \in \left[0, \frac{\pi}{2}\right] \quad (17)$$

For the stress state indicator:

$$\varepsilon_c(\eta) = a_2 * \exp\left(-\eta * \ln\left(\frac{(1-\eta)*a_1}{2*a_2} + \frac{(1-\eta)*a_2}{2*a_3}\right)\right), \eta \in [-1, 1] \quad (18)$$

The curve of boundary deformations during stationary deformation:

$$\begin{cases} \eta = \omega(\tau_*(m)) \\ \varepsilon_*(\tau_*(m), m) = m * \int_0^{\tau_*(m)} \frac{1}{f(2, \tau) * \cos^2(\tau)} \end{cases} \quad (19)$$

$$\frac{m}{a_2} * \int_0^{\tau_*(m)} \frac{\exp\left[\omega(\tau) * \ln\left(a_1 * \frac{1-\omega(\tau)}{2*a_2} + a_2 * \frac{1+\omega(\tau)}{2*a_3}\right)\right]}{f(2, \tau) * \cos^2(\tau)} * dt - 1 = 0$$

The boundary state model has the form:

In Figure 11 shows the dependence of the boundary state of the material on the intensity of barrel formation during deposition [5].

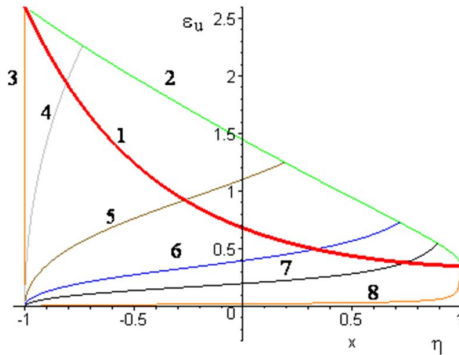
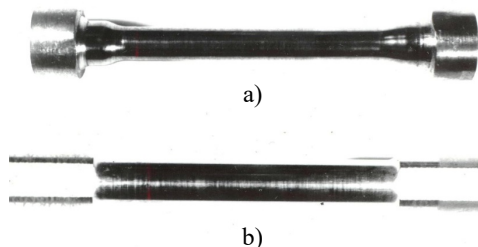

Figure 11. Dependence of the boundary state of the material on the intensity of barrel formation during deposition: 3-8 deformation trajectories, where 3 – m=30; 4 – 2; 5 – 0.5; 6 – 0.18; 7 – 0.09; 8 – 0.01



**Figure 12. Cylindrical samples for plasticity testing:
a – for tension, b – for torsion**

In Figure 12 samples for tensile and torsional testing of metals are presented.

The advantage of torsion, when testing metals for plasticity, is that in the process of torsion of cylindrical stress samples, $\sigma_1 = -\sigma_3$, and $\sigma_2 = 0$, therefore, constant values of indicators $\eta = 0$ and $\mu_\sigma = 0$. The intensity of deformations on the surface is determined by the ratio:

$$\varepsilon_u = \frac{tg\alpha}{\sqrt{3}}, \quad (20)$$

where α is the shift angle measured between the initial and current position of the profile risk on the surface of the twisted cylindrical sample. When determining the boundary deformation at the moment of destruction of the sample, the angle measurement α must be carried out directly near the place of failure.

As a result of the research, it was established that the curves of limit deformations, with sufficient accuracy for practice, can be built based on the results of testing samples for torsion and deposition.

In the table 1 shows the boundary deformations of metals during deposition $\varepsilon_*(\eta = -1)$, twisting $\varepsilon_*(\eta = 0)$ and the coefficient of sensitivity of plasticity to the stress state indicator λ .

In this case, the value of the boundaries deformations during stretching can be obtained using the approximate dependence of V. A. Ogorodnikov [5], which has been tested for various metals:

$$\varepsilon_* = \varepsilon_*(\eta = 0) \exp \left[-\eta \ln \frac{\varepsilon_*(\eta = -1)}{\varepsilon_*(\eta = 0)} \right], \quad (21)$$

In Figure 13 shows the curves of boundaries deformations of a number of metals using the results of the studies given in the Table 1 and approximations (21).

It should be noted that the possible inaccuracies of the display of the dependence of plasticity on the stress state scheme, when using flat plasticity diagrams, are more typical for areas of comprehensive compression, where the danger of metal destruction in technological processes is not the main limiting factor. In addition, in most deformability criteria the integrand function contains a model of the dependence of the boundary deformation ε_* precisely on the indicator η .

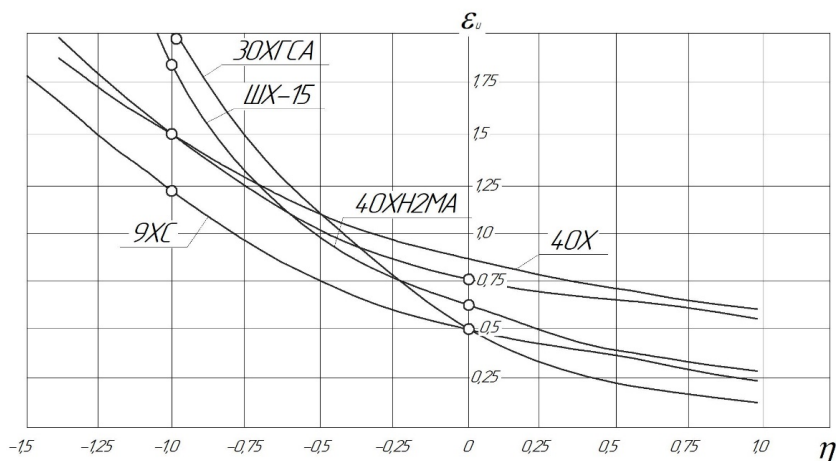

Figure 13. Curves of boundaries deformations of a number of steels

That is why the curves of boundaries deformations in the coordinates $\varepsilon_* = \varepsilon_*(\eta)$ received the greatest spread in the study of the dependence of plasticity on the scheme of the stress state.

At the same time, the contradictions of plasticity values obtained during different types of tests remain problematic. The definition of plasticity of metal under conditions of single axial tension without loss of deformation resistance is a certain solution to the noted contradictions.

5. Conclusions

The analysis of existing methods of testing metals for plasticity and construction of boundary deformation curves revealed their disadvantages due to the instability of the stress state indicator. The problems of studying the plasticity of metals are related to the lack of ways to construct a "single" curve of boundary deformations due to the formation of a neck during the stretching of cylindrical samples and the formation of a barrel during their deposition and the increase in plasticity due to the implementation of complex deformation.

According to the results of the research, an equation was obtained for determining the increase in plasticity depending on the ratio of the radius of curvature of the neck to its diameter, which allows taking into account the effect of an "abnormal" increase in plasticity in the case of neck formation during stretching. An experimental-calculation method is considered, which involves the construction of deformation paths during the deposition of cylindrical samples and the correction of the boundary deformation using the deformability criterion. A method of rolling a cylindrical sample into a wedge with rolls, the radii of which increase during the rolling process, has been developed.

The method provides the possibility of testing cylindrical samples under constant stress and allows obtaining values of plasticity under conditions of single axial tension. Curves of boundary deformations, with the precision necessary for practice, are proposed to be built based on the results of testing samples for torsion and deposition using an approximate dependence. Curves of boundaries deformations of a number of steels were constructed according to the given method.

The proposed test methods make it possible to determine the plasticity of metals under various constant stress states, which contributes to increasing the reliability of assessing their deformability in PMP processes. This, in turn, makes it possible to develop resource-saving stamping and rolling processes by: reducing the number of transitions and preventing defects from destruction; improvement of the quality of products as a result of the formation of a favorable microstructure of the material and limited use of the resource of plasticity.

References:

1. Matviychuk V. A., Aliyev I. S. (2009) Improvement of processes of local rotational pressure processing based on the analysis of deformability of metals. Kramatorsk: DGMA. Monograph.
2. Kraevsky V. O., Matviychuk V. A., Mikhalevich V. M. (2003) Influence of technological parameters on the kinematics of cold end rolling. Improvement of pressure treatment processes and equipment in mechanical engineering and metallurgy. Kramatorsk-Slovyansk, p. 291.
3. Ogorodnikov V. A. (1983) Estimation of deformability of metals during pressure treatment. Kyiv: Higher School, p. 175.
4. Mikhalevich V. M. (1998) Tensor models of damage accumulation. Vinnytsia: «UNIVERSUM – Vinnytsia», p. 195.
5. Mikhalevich V. M., Dobranyuk Yu. V. (2015) Analytical presentation of the maximum radius of cylindrical workpieces during axisymmetric deposition with barrel formation. *Herald of mechanical engineering and transport*, no. 1, pp. 59–66.
6. Matviychuk V. A. (2007) On increasing the plasticity of metals in cases of the appearance of a neck during stretching. Forging and stamping production. *Processing of metals by pressure*, no. 9, pp. 18–22.
7. Matviychuk V. A., Mykhalevych V. M., Dobranyuk Yu. V., Bubnovska I. A. (2016) Method of determining the plasticity of metals by rolling cylindrical samples into a wedge, IPC G01N 3/08 (2006/01). No. 109984, September 26.
8. Shtuts A., Kolisnyk M., Yavdyk V. (2018) Improvement of processes of rolling stamping on the basis of investigation of technological parameters on the mechanics of workpieces formation. *MOTROL. Commission of Motorization and Energetics in Agriculture*, pp. 19–25.
9. Matviychuk V. A., Kolisnyk M. A., Shtuts A. A. (2018) Study of the stress-strain state of the material of the blanks during direct extrusion by the rolling stamping method. *Technology, energy, transport of agricultural industry*, no. 3(102), pp. 77–84.
10. Shtuts A., Kolisnyk M., Vydmysh A., Voznyak O., Baraban S., Kulakov P. (2020) Improvement of Stamping by Rolling Processes of Pipe and Cylindrical Blades on Experimental Research. *Actual Challenges in Energy & Mining*, vol. 844, pp. 168–181. (Scopus SNIP: 0.29).
11. Matviychuk V., Shtuts A., Kolisnyk M., Kupchuk I., Derevenko I. (2022) Investigation of the tubular and cylindrical billets stamping by rolling process with the use of computer simulation. *Periodica Polytechnica Mechanical Engineering*, vol. 66, no. 1, pp. 51–58. DOI: <https://doi.org/10.3311/PPme.18659>
12. Kupchuk I., Kolisnyk M., Shtuts A., Paladii M. (2021) Development of the technological process of forming rings from sheet samples by stamping rollers and rotary hood. *Bulletin of the Transilvania University of Braşov. Series I: Engineering Sciences*, vol. 14 (63), no. 2, pp. 1–13. DOI: <https://doi.org/10.31926/but.ens.2021.14.63.2.1>
13. Kupchuk I., Kolisnyk M., Shtuts A., Paladii M., Didyk A. (2021) Experimental evaluation stress-strain state for billets during rolling stamping by rollers. *Colloquium-journal*, no. 16 (103), część 1, pp. 40–48.

14. Andrii Shtuts, Mykola Kolisnyk, Oleksandr Voznyak (2022) Studying the dynamic characteristics of closed system of gravity concrete mixer's electric drive by means of computer simulation. *AGRICULTURAL ENGINEERING*, vol. 54, pp. 49–61
15. Wozniak O. M., Stuts A. A., Kolisnyk M. A. (2021) Modern systems of electric drives. Theory and practice (part 1): teaching. manual Vinnytsia National Agrarian University. Vinnytsia: LLC “CREATIONS”, 280 p.
16. Shtuts A. A., Matviychuk V. A. (2016) Computer modeling of the rolling stamping process of pipe blanks. *Technical sciences: Collection of scientific papers*, no. 1 (95), pp. 178–184.
17. Matviychuk V. A., Kolisnyk M. A., Shtuts A. A. (2018) Study of the stress-strain state of the material of the blanks during direct extrusion by the rolling stamping method. *Technology, energy, transport of agricultural industry*, no. 3 (102), pp. 77–84.
18. Stuts A. A. (2020) Computer modeling of the rolling stamping process of cylindrical and tubular blanks using the deform-3d software complex. *Vibrations in engineering and technology*, no. 4 (99), pp. 101–113.
19. Shtuts A. A., Sluzhaluk M. O. (2020) Research of rolling stamping processes using surface heating of blanks. *Vibrations in engineering and technology*, no. 2 (97), pp. 138–148.
20. Matviychuk V. A. (2007) On increasing the plasticity of metals in cases of the appearance of a neck during stretching. Forging and stamping production. *Processing of metals by pressure*, no. 9, pp. 18–22.
21. Mikhalevich V. M., Dobranyuk Yu. V. (2015) Analytical presentation of the maximum radius of cylindrical workpieces during axisymmetric deposition with barrel formation. *Herald of mechanical engineering and transport*, no. 1, pp. 59–66.
22. Matviychuk V. A., Mykhalevych V. M., Dobranyuk Yu. V., Bubnovska I. A. A method of determining the plasticity of metals by rolling cylindrical samples into a wedge, IPC G01N 3/08 (2006/01). № 109984, September 26, 2016.
23. Paziuk V., Vyshnevskiy V., Tokarchuk O., Kupchuk I. (2021) Substantiation of the energy efficient schedules of drying grain seeds. *Bulletin of the Transilvania University of Braşov. Series II: Forestry, Wood Industry, Agricultural Food Engineering*, vol. 14 (63), no. 2, pp. 137–146. DOI: <https://doi.org/10.31926/but.fwiafe.2021.14.63.2.13>
24. Poberezhets J., Kupchuk I. (2021) Effectiveness of the use of probiotics in the diet of broiler chickens. *Roczniki Naukowe Polskiego Towarzystwa Zootechnicznego*, vol. 17 (4), pp. 9–16.
25. Poberezhets J., Kupchuk I., Yaropud V., Burlaka S. (2021) Digestibility of nutrients and broiler chicken productivity under the action of probiotic enteroactive. *Bulletin of the Khmelnytskyi National University. Series: Technical sciences*, no. 4 (299), pp. 182–186.
26. Yaropud V., Hunko I., Aliiev E., Kupchuk I. (2021) Justification of the mechatronic system for pigsty microclimate maintenance. *Agraarteadus*, vol. 32, no. 2, pp. 212–218. DOI: <https://doi.org/10.15159/jas.21.21>

27. Mazur V., Tkachuk O., Pantsyreva H., Kupchuk I., Mordvaniuk M., Chynchyk O. (2021) Ecological suitability peas (*Pisum Sativum*) varieties to climate change in Ukraine. *Agraarteadus*, vol. 32, no. 2, pp. 276–283. DOI: <https://doi.org/10.15159/jas.21.26>

28. Palamarchuk V., Honcharuk I., Telekalo N., Krychkovskiy V., Kupchuk I., Mordvaniuk M. (2021) Modeling of hybrid cultivation technology corn to ensure energy efficiency for sustainable rural development. *Ukrainian Journal of Ecology*, no. 11(7), pp. 204–211. DOI: https://doi.org/10.15421/2021_260

29. Paziuk V., Vyshnevskiy V., Tokarchuk O., Kupchuk I. (2021) Substantiation of the energy efficient schedules of drying grain seeds. *Bulletin of the Transilvania University of Braşov. Series II: Forestry, Wood Industry, Agricultural Food Engineering*, vol. 14 (63), no. 2, pp. 137–146. DOI: <https://doi.org/10.31926/but.fwiafe.2021.14.63.2.13>

30. Poberezhets J., Kupchuk I. (2021) Effectiveness of the use of probiotics in the diet of broiler chickens. *Roczniki Naukowe Polskiego Towarzystwa Zootechnicznego*, vol. 17 (4), pp. 9–16.

31. Poberezhets J., Kupchuk I., Yaropud V., Burlaka S. (2021) Digestibility of nutrients and broiler chicken productivity under the action of probiotic enteroactive. *Bulletin of the Khmelnytskyi National University. Series: Technical sciences*, no. 4 (299), pp. 182–186.

32. Poberezhets Ju., Chudak R., Kupchuk, I., Yaropud V., Rutkevych V. (2021) Effect of probiotic supplement on nutrient digestibility and production traits on broiler chicken. *Agraarteadus*, vol. 32, no. 2, pp. 296–302. DOI: <https://doi.org/10.15159/jas.21.28>

Izdevniecība “Baltija Publishing”
Valdeķu iela 62 – 156, Rīga, LV-1058
E-māil: office@baltijapublishing.lv

Iespiests tipogrāfijā SIA “Izdevniecība “Baltija Publishing”
Parakstīts iespiešanai: 2022. gada 30. septembris
Tirāža 300 eks.